



VOLUME 1, MARCH 2023  
ISSN 2987-2219

# PROCESSOR

PROCEEDING ON COMPUTER AND  
ELECTRICAL EDUCATION RESEARCH  
THE FUTURE OF TECHNICAL VOCATIONAL AND  
EDUCATION TRAINING IN A DIGITAL WORLD

Banda Aceh,  
22 February 2023

## ORGANIZED BY:

Program Studi Pendidikan Teknik Elektro  
Program Studi Pendidikan Teknologi Informasi  
Fakultas Tarbiyah dan Keguruan UIN Ar-Raniry Banda Aceh

# PROCESSOR

## PROCEEDING ON COMPUTER AND ELECTRICAL EDUCATION RESEARCH “THE FUTURE OF TECHNICAL VOCATIONAL AND EDUCATION TRAINING IN A DIGITAL WORLD”

### SUSUNAN DEWAN REDAKSI PROCESSOR 2023

#### **Keynote Speaker:**

Prof. Dr. Ir. Ivan Hanafi, M.Pd (UNJ)

Prof. Dr. Ramlee Mustapha (UPSI)

Prof. Safrul Muluk, S.Ag., M.A., Ph.d (UIN Ar-Raniry)

#### **Pengarah:**

Prof. Safrul Muluk, S.Ag., M.A., Ph.d. (UIN Ar-Raniry)

#### **Penanggung Jawab:**

Mira Maisura, M.Sc. (UIN Ar-Raniry)

Hari Anna Lastya, M.T. (UIN Ar-Raniry)

#### **Ketua Pelaksana**

Sadrina, S.T., M.Sc. (UIN Ar-Raniry)

#### **Reviewer:**

Prof. Dr. Ir. Ivan Hanafi, M.Pd (UNJ)

Prof. Dr. Ramlee Mustapha (UPSI)

Ridwan, M.T. (UIN Ar-Raniry)

Sadrina, S.T., M.Sc. (UIN Ar-Raniry)

Aulia Syarif Aziz, M.Sc. (UIN Ar-Raniry)

M. Ikhsan, M.T. (UIN Ar-Raniry)

Raihan Islamadina, M.T. (UIN Ar-Raniry)

Rahmat Musfikar, M.Kom. (UIN Ar-Raniry)

Fathiah, M.Eng. (UIN Ar-Raniry)

Sarini Vita Dewi, M.Eng. (UIN Ar-Raniry)

Mursyidin, M.T. (UIN Ar-Raniry)

#### **Editor:**

M. Rizal Fachri, M.T. (UIN Ar-Raniry)

Baihaqi, M.T. (UIN Ar-Raniry)

Firmansyah. MT. (UIN Ar-Raniry)

ISSN 2987-2219

Banda Aceh, Maret 2023

Diterbitkan oleh:  
Universitas Islam Negeri Ar-Raniry

**Tanggal Kegiatan:**  
22 Februari 2023

**Lokasi Kegiatan:**  
Fakultas Tarbiyah dan Keguruan UIN Ar-Raniry Banda Aceh

**Contact:**  
+62896-1675-2172 (Prodi Pendidikan Teknologi Informasi)  
[ftk.prodipti@ar-raniry.ac.id](mailto:ftk.prodipti@ar-raniry.ac.id)

**Sekretariat:**  
Prodi PTI dan PTE. Fakultas Tarbiyah dan Keguruan. UIN Ar-Raniry Banda Aceh, Indonesia Jl.  
Syeikh Abdul Rauf, Darussalam - Banda Aceh 23111

**Penerimaan artikel**  
Due date atau deadline: 06 Februari 2023  
Notification of Acceptance: 10 Februari 2023  
Camera Ready Submission: 17 Februari 2023  
Conference date : 22 Februari 2023

## DAFTAR ISI

<b>A SURVEY OF FACILITY MANAGEMENT GREEN SKILLS COMPETENCY AMONG TVET EDUCATORS AND STUDENTS IN A PUBLIC UNIVERSITY IN MALAYSIA</b>	1 – 22
<i>Shri Dayalam James @ Batumalay, Ramlee Mustapha, Theepa Paramasivam, and Irdyanti Mat Nashir</i>	
<b>THE EVALUATION OF BUILDING ELECTRICAL INSTALLATION TRAINING PROGRAM AT THE BANDA ACEH WORK TRAINING CENTER (BLK)</b>	23 – 27
<i>Habibuddion Muslihin, Sadrina, and Husnizar</i>	
<b>AN ANALYSIS OF TEAMVIEWER AND ULTRAVNC PERFORMANCE ON WIFI NETWORKS</b>	28 – 33
<i>Aulia Syarif Aziz, Syakirun Mukmin, Ridwan, dan Firmansyah</i>	
<b>CONTROL AND MONITORING SYSTEM DESIGN OF INTERNET-BASED ELECTRICAL INSTALLATIONS</b>	34 – 47
<i>Abdul Hanif, Hari Anna Lastya, Muhammad Ikhsan</i>	
<b>DESIGN OF PLC-BASED ELECTRIC MOTOR CONTROL TRAINER IN COURSES ELECTRIC MACHINERY CONTROL PRACTICE</b>	48 – 55
<i>Mirza Sultan Farza, Malahayati, and Muhammad Ikhsan</i>	
<b>HAZOP METHOD FOR ELECTRICAL K3 ANALYSIS SETTLEMENT IN THE VILLAGE JAGONG JEGET-ACEH TENGAH</b>	56 – 62
<i>Raihan Islamadina, Ike Wirda Sari, and Hadi Kurniawan</i>	
<b>DESIGN OF AUTOMATIC UNLOCKING SYSTEMS WITH BASED NOTIFICATIONS RFID (RADIO FREQUENCY IDENTIFICATION)</b>	63 – 71
<i>Fathiah, Sri Wahyuni, and Abdul Malek Safar</i>	
<b>APPLICATION OF PARTICIPATORY METHODS IN MOTORCYCLE ELECTRICAL MAINTENANCE LEARNING MATERIALS FOR INDUSTRIAL WORK PRACTICES (PRAKERIN) CLASS XI SMK NEGERI 4 BANDA ACEH</b>	72 – 77
<i>Akmilul Fazlan, Muhammad Rizal Fachri, and Husnizar</i>	
<b>DEVELOPMENT OF SENSOR-BASED PROTOTYPE ROBOT FOR AUTOMATED FOOD DELIVERY</b>	78 – 83
<i>Ridwan, Muhammad Fauzan, and Hadi Kurniawan</i>	
<b>ANALYSIS OF NETWORK PERFORMANCE AT SMKN 1 TAKENGON</b>	84 – 90
<i>Firmansyah, Nikma Marwah Mah Bengi, Hazrullah, Aulia Syarif Aziz</i>	
<b>DEVELOPMENT OF DUAL-AXIS SUN TRACKER BASED ON TETRAHEDRON GEOMETRY USING PHOTOTRANSISTOR SENSOR</b>	91 – 102
<i>Hari Anna Lastya, Yuwaldi Away, Tarmizi, Ira Devi Sara, M. Ikhsan, Nikmal Maula Mirdha</i>	

**A SURVEY OF FACILITY MANAGEMENT GREEN SKILLS  
COMPETENCY AMONG TVET EDUCATORS AND STUDENTS  
IN A PUBLIC UNIVERSITY IN MALAYSIA**

**Shri Dayalam James @ Batumalay<sup>1</sup>, Ramlee Mustapha<sup>2</sup>, Theepa Paramasivam<sup>3</sup>,  
and Irdayanti Mat Nashir<sup>4</sup>**

<sup>1,2,3,4</sup>Faculty of Technical and Vocational Education, Sultan Abdul Jalil Campus, Sultan  
Idris Education University, Tanjung Malim, 35900, Perak, Malaysia  
E-mail: dayalamshri@gmail.com

**Abstract**

Green skills are sometimes referred to as sustainable development skills because they are associated with technical skills, knowledge, values, and attitudes required in the workforce to produce and promote sustainable, social, economic, and environmental results in business, industries, and the community. Technical and Vocational Education and Training (TVET) plays an important role in promoting the development of a sustainable workforce by educating and training students through a more valuable sustainability-related curriculum, as well as contributing to the development of the Facility Management (FM) industry. The purpose of this study was to investigate the green skills competency of third- and final-year TVET undergraduate students and educators from a public university in Malaysia. Based on Pavlova's green skills competency and ecological modernization theory by Howes et al., this study constructs a conceptual framework. This study includes 40 Faculty of Technical and Vocational educators and 81 third- and final-year students from Engineering Technology, Agriculture, and Family and Consumer Science programmes. The data were collected using an online Google form. In this study, descriptive statistics such as frequency ( $f$ ) and percentage (%) were used. Thematic analysis was also employed to categorise open-ended items. This study emphasises qualitative analysis findings to relate green skills competency of the respondents. The findings of this study reveal that the respondents' claims that they understood the green concept. They thought green skills as sustainability, green technology, recycling activities, and renewable energy. Most of the participants agreed that they possessed green knowledge and skills. They also stated the benefits of green technology which included creating sustainable environment, providing renewable energy, promoting recycling activities, saving operational costs, improving wellbeing, enhancing energy saving, providing more green jobs opportunities and encouraging the use of green materials. However, the most challenging barrier is inadequate facilities to support green skills related activities. Next, educators also highlighted the lack of proper green curriculum and the lecturers lack of motivation as the other barriers faced while teaching green skills. Finally, the respondents made suggestions to their institution on how to enhance green skills competency among TVET educators and students. They stated that educators should conduct seminar and training related to green skills to their students. Followed by need to restructure green curriculum, ensuring adequate resources are available, cultivating green attitude and ensuring policy is implemented at the institutional and national levels.

**Keywords:** *Green skills, Green Technology, TVET, Facility Management, Sustainable Development*

## **1. Introduction**

Facility management (FM) is a multidisciplinary profession that integrates people, place, process, and technology to ensure the operation, comfort, safety, and efficiency of the physical environment (IFMA, 2022) [1]. Facilities Management has progressed from sustaining and adapting to the increasingly important job of contributing to work organisation productivity. This shift from the physical to the human aspect of the FM profession has occurred gradually over time, but as the cost of people, including recruiting, retention, and performance, rises, so does our influence on the firm (Michel, n.d.) [2]. The infrastructure of higher education institutions is defined as physical assets and facilities that directly contribute to the efficiency of the educational system's teaching and learning. Physical and non-physical facilities, as well as the surrounding environment, provide the institutions with the necessary structure and atmosphere for teaching and learning activities. Non-physical facilities include indoor air quality, acoustics, natural lighting, artificial lighting, temperature, ventilation, and cleanliness (Abdullahi & Yusoff, 2018) [3].

FM refers to the integration of processes within an organisation in order to maintain and develop agreed-upon services that support and improve the effectiveness of the organization's primary activities (IWFM, 2022) [4]. In summary, FM focuses on facility and consumer coordination requirements in order to meet standards. To ensure high-quality and effective FM, various disciplines such as engineering, architecture, business management, and behavioural science are required to achieve the best facilities management. As a result, being a facility manager is difficult because it requires a manager's abilities, competence, and extensive experience in managing and maintaining a facility (Isa et al., 2016) [5].

There are substantial advantages to green FM; moreover, this article focuses how green FM can monitor energy consumption while extending the life cycle of the building. Building maintenance can help to extend the life of the fabric, service, and structure of a building. A very well FM system has been installed in a building can save up to 15% of the structure's energy usage. In addition, the facility's expected life span will be increased. As a result, "green maintenance" has become an essential component of meeting sustainability initiatives (Keeping & Shiers, 1996) [6]. Simple cleaning and security services are unable to meet the market's demand for FM. The trend among stakeholders will be to provide more value-added solutions (Cant, 2004) [7].

Because of the growing governmental push towards sustainability, facility managers are expected to be in high demand. In 2020, 20,000 'green collar' PMETs, also known as professionals, managers, executives, and technicians, are expected will need training in green facility development, design, construction, operation, and maintenance (Sustainability, 2014) [8].

Malaysian production plants are innovating and becoming more inventive as automation systems are installed all across the manufacturing process. The FM system, power management, and other departments such as logistics, warehouse, quality, and maintenance will be linked to the production and manufacturing systems. Data can be transferred from one system to another, making manufacturing operations run more smoothly and efficiently. Furthermore, the production plant is globally connected via the Internet. As a result, control and monitoring may take place beyond the production plant, making smart factories more adaptable (Wang et al., 2016) [9]. The production line must be adaptable enough to the product it will produce (Weyer et al., 2015) [10]. The product

**A SURVEY OF FACILITY MANAGEMENT GREEN SKILLS COMPETENCY AMONG  
TVET EDUCATORS AND STUDENTS IN A PUBLIC UNIVERSITY IN MALAYSIA**

will be created using standard manufacturing procedures. Changes or updates to a product can be made quickly, and the entire manufacturing line does not need to be reconfigured.

TVET is a tool that enables to develop a long-term workforce. To address globalisation concerns such as climate change and other negative consequences, a workforce with sustainability ideals is required. Technical and vocational education is critical in educating students to be environmentally conscious through a more sustainability-related curriculum. As a result, green skills must be taught in TVET programmes. Malaysia's educational and training institutions must devise a strategy to inculcate a deep understanding of the importance of environmental preservation for everyone's well-being in the millennial population (Kamis et al., 2017) [11]. Greening an organization ensures the participation and collaboration of several key stakeholders and cannot be accomplished by a few dedicated individuals alone. Facility managers are among the relevant internal stakeholders who should be kept up to date on the TVET institution's greening initiatives on a regular basis because they can help or hinder the process to some extent. They must be applicable and relevant to the greening system (Mertineit & Huyen, 2016) [12].

The green paradigm is critical in work and life in the twenty-first century (Ramlee et al., 2019) [13]. The United Nations has established several international agendas and programmes, such as the Sustainable Development Goals and the Millennium Development Goals, to conserve and sustain the world. To achieve its goals, the 2030 Agenda for Sustainable Development, as well as the 17 Sustainable Development Goals (SDGs) adopted by the United Nations (UN) through member countries in 2015, place a strong emphasis on education and training (United Nations, 2015) [14]. The Sustainable Development Goals went into effect on January 1, 2016. They demand that measures be taken to promote prosperity and progress. At the same time, the environment is being safeguarded. Various social demands, such as education, health, social protection, and job opportunities, are being met while combating climate change and conserving the environment and reducing poverty through economic growth. The UNESCO Technical and Vocational Education and Training (TVET) strategy aims to assist member countries in transitioning to more sustainable communities and economies (UNESCO, 2016) [15].

As a substantial provider of skilled labour, TVET is responsible for incorporating green skills into teaching and learning practises in order to achieve a more sustainable future (Pavlova, 2014). Thus, according Pavlova (2014) [16], the need to address global issues such as climate change and carbon emissions, environmental degradation and pollution, health, and poverty requires developed countries to embrace innovation-driven growth initiatives, which TVET should promote. Economic gains from green restructuring should be accompanied by human capital development that has a significant impact on skills. Table 1 illustrates the targets for developing general green skills by delving seventeen SDGs into the ten SDGs (UNEVOC Network, 2019) [17].

TABLE 1 TEN SDGS IN BUILDING GREEN SKILLS

SDG	Goals
6	Clean Water and Sanitation
7	Affordable and Clean Energy
8	Decent work and economic growth
9	Industry, Innovation, and Infrastructure
11	Sustainable Cities and Communities
12	Responsible Consumption and Production
13	Climate Action



**A SURVEY OF FACILITY MANAGEMENT GREEN SKILLS COMPETENCY AMONG TVET EDUCATORS AND STUDENTS IN A PUBLIC UNIVERSITY IN MALAYSIA**

14	Life Below Water
15	Life on Land
16	Peace, Justice and Strong Institutions

Source: UNEVOC Network (2019)

UNESCO formally announced its TVET Strategy 2016-2021 on World Youth Skills Day, July 15, 2016, in Bonn. The plan takes into account the Education 2030 Framework for Action (FAA) for achieving SDG4, which focuses to mobilise all countries and partners around SDG4, its targets and provides solutions for implementing, coordinating, financing, and monitoring SDG4 (UNEVOC Network, 2019) [17]. The strategy supports UNESCO Member States' efforts to improve the relevance of their TVET systems in order to provide all youth and adults with the skills required for the job, stable employment, enterprise development, and continuous learning, as well as significantly contribute to the successful implementation of the 2030 Agenda for Sustainable Development. Suggestions for how countries can develop contextually relevant plans that take into account diverse national realities, capacities, and levels of development while remaining true to national goals and priorities (UNESCO, 2016) [15]. UNESCO could help to accelerate the transition to green economies and sustainable humanities by promoting green skills as one of the priority areas depicted in Figure 1.

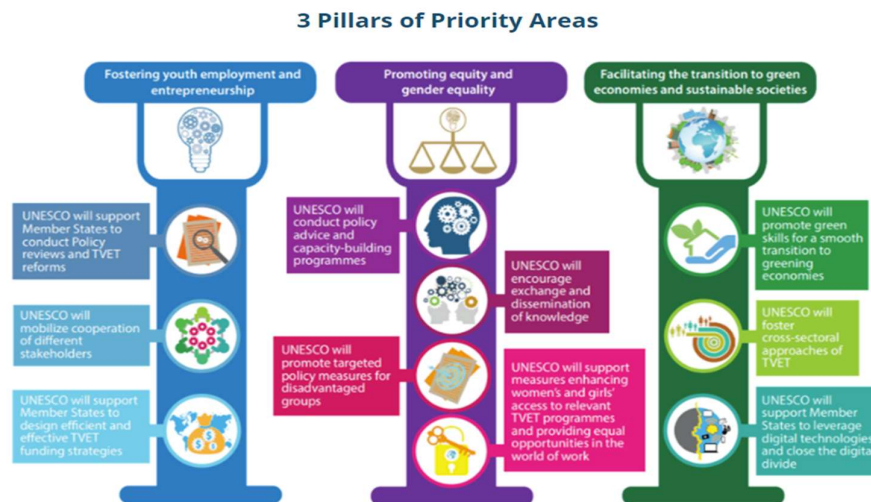

Figure 1. Three Pillars of Priority Areas for UNESCO Strategy for Technical and Vocational Education and Training (TVET) 2016-2021. Source: UNESCO (2016)

Centres of Vocational Excellence (CoVEs) are excellent hubs for training in specific sectors, from foundation training for novices to ongoing up-skilling and re-skilling for experienced workers. The centres, which operate locally and have regional solid innovation ecosystems, provide flexible and timely training to meet current industry requirements, acting as motivators for local company investment while ensuring a stable supply of competent employees. Furthermore, CoVEs provide business information and act as innovation hubs to support their trainees' entrepreneurial initiatives, particularly in Small and Medium Enterprises (SMEs). Excellence in vocational education and training (VET) confirms high-quality skills and competencies in committing to well-paying jobs and long-term opportunities that meet the requirements of a diverse, innovative, and



## A SURVEY OF FACILITY MANAGEMENT GREEN SKILLS COMPETENCY AMONG TVET EDUCATORS AND STUDENTS IN A PUBLIC UNIVERSITY IN MALAYSIA

sustainable economy (European Commission, 2021) [18]. Learners can obtain vocational and vital capabilities through high-quality education by engaging in research, teaching, innovation, and collaboration with other educational, training, and industry sectors. Client satisfaction, the establishment of creative workplace collaborations, and the enhancement of continuous professional development of teaching and training personnel, innovative teaching techniques, mobility, and globalization initiatives all contribute to these efforts.

Green economy invention and urban greening of Three-Level Centres of Professional Excellence (3LoE) led by Hanse-Parlament in Germany, collaborated with Austria, Italy, Latvia, Lithuania, Poland, Spain, and associated with 60 European Union nations, emphasises the broad provision of green skills focusing on energy, climate, and environmental protection. The 3LoE strengthens CoVEs' green economies by implementing a wide range of green economies through digitalization, entrepreneurship, VET, and higher education initiatives. The primary goals are to continuously improve skills, ensure demand for early adopters and entrepreneurs, and boost SMEs' competitiveness in the green economy. By implementing dual vocational training between learning sites in businesses and centres, qualified and innovative SMEs achieve energy savings, renewable energy use, and environmental and climate protection in their industrial practises. As a result, long-term sustainable collaboration between CoVEs and SMEs increases the quantity and value of young entrepreneurs' practical activities while also improving the skills of SME experts and managers in applying green economy practises and promoting green economy entrepreneurship through secured business startups and transfers (3LoE, 2021) [19].

Since 2009, KeTTHA in Malaysia has strategized Green Technology Master Plan 2017-2030 by addressing numerous efforts that have demonstrated green technology can help decouple green economic growth from natural capital depletion. Figure 2 depicts the GDP contribution generated by adopting and implementing green technology-based practises, systems, and goods. The Green Technology Master Plan (GTMP) (2017-2030) concentrated on four key areas. The first step is for governments to develop green procurement policies and to examine all aspects of their operations for opportunities to implement green technology-based processes, systems, and items. The second step is to implement targeted programmes that encourage informed purchasing decisions based on increased environmental awareness via the use of green technologies. The third aspect emphasises R & D & C, which will shift Malaysia away from adopting and adapting non-domestic technology and towards establishing its global technical innovation. The fourth approach emphasised human capital development in order to achieve innovation and excellence in green economic expansion (KeTTHA, 2017) [20].

**A SURVEY OF FACILITY MANAGEMENT GREEN SKILLS COMPETENCY AMONG TVET EDUCATORS AND STUDENTS IN A PUBLIC UNIVERSITY IN MALAYSIA**

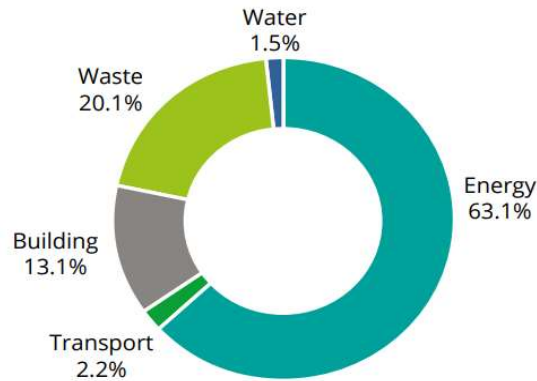

Figure 2. Contribution of Green Technology (by sector) to GDP in 2013. *Source:* KeTTHA (2017)

From 2011 to 2015, the Tenth Malaysia Plan (10th MP) would prioritise 12 National Key Economic Areas (NKEAs) with high income potential. The government introduced the AFFIRM framework of Awareness, Faculty, Finance, Infrastructure, Research, and Marketing during the 10th MP. It emphasised the government's holistic ecosystem development strategy for environmental sustainability. This framework concept emphasises the importance of all Malaysians recognising environmental protection and conservation as a shared responsibility on how the Twelfth Malaysia Plan 2021-2025 (12th MP) prioritised critical areas for environmental sustainability (The Edge Market, 2021) [21]. The 12MP is organised around three key goals: (a) resetting the economy, (b) strengthening security, and (c) wellbeing and inclusion, with four policy enablers addressed: nurturing future talent, increasing technology adoption and innovation, improving connectivity and transportation infrastructure, and reinforcing government while accepting the new benchmark.

Green skills are the basis of the green transition and the key to unlocking the human capital required to successfully move it forward. More opportunities for those with green expertise, on the other hand, are required. Employees who do not possess green skills must be retrained. As a result, green skills should be included in 21st-century skill sets for current and future generations (Kamis et al., 2016) [22]. Greener jobs necessitate the acquisition of greener skills. LinkedIn's new green skill taxonomy can quantify the extent to which different countries, sectors, and jobs use current and recent evolution of green skills, known as green skill intensity, in meeting demand and developing supply in each sector and country. In 2019, the tide shifted in favour of green workers, with green hiring rates outperforming overall hiring rates in the majority of economies around the world, implying that green workers were hired at a higher rate than non-green workers globally. Simultaneously, the proportion of green talents in the global workforce has increased from 9.6 percent in 2015 to 13.3 percent in 2021, with a 6% annual growth rate and a 38 percent cumulative growth rate (LinkedIn, 2022) [23].

TVET stands for Technical and Vocational Education and Training and is administered by the Malaysian Ministry of Education. TVET is an educational and training platform that prepares candidates for the real world of work and exposes them to competent employability skills through practical, psychomotor, and industrial exposure. By integrating knowledge technological advancement and meeting global employability mobility, TVET contributes to the country's economic growth (Ismail et al., 2021) [24].

**A SURVEY OF FACILITY MANAGEMENT GREEN SKILLS COMPETENCY AMONG TVET EDUCATORS AND STUDENTS IN A PUBLIC UNIVERSITY IN MALAYSIA**

Green skills are the abilities required to participate in the green economy by creating new and innovative occupations with specific skill profiles, qualifications, and training frameworks, modifying current jobs to include green experience, and participating in multiple positions that can incorporate green skills and green technology in R&D.

The 11th Malaysia Plan (11MP) is commendable and a step in the right direction by proposing that TVET become a dual-track system equivalent to an academic pathway through the Malaysian Qualification Framework, while also increasing the efficiency and effectiveness of TVET in meeting industry demand now and in the future (Da Wan et al., 2018) [25]. Green skills can be integrated into occupational competencies such as engineering, technology, science, maintenance, repair, operation (MRO) management, monitoring, and other relevant fields, according to Vona et al. (2015) [26]. Table 2 shows data on green occupations classified by greenness level, which helps determine the importance of green skills within each profession. Vona et al. (2015) [26] also emphasised the importance of a comprehensive set of green skills to supplement green jobs and educational programmes. As shown in Table 2, TVET is critical in this regard.

**TABLE 2 GREEN OCCUPATIONS BY LEVEL OF GREENNESS**

Occupations Category	Level of greenness equals to 1	Level of greenness greater than 0.5 and equals 0.3	Level of greenness lesser than 0.3
Green enriched occupations	Environmental Engineers and Technicians, Hazardous Material Removers	Engineers in Aerospace Technology, Atmospheric Scientists, Automotive Technicians, Roofers	Construction workers, Maintenance & Repair Workers, Inspectors, Marketing Functional Managers
Innovative green occupations	Wind Energy Engineers and Technicians, Fuel Cell Technicians, Coordinators in Recycling Centre	Supply Chain Managers, Biochemical Engineers, Technicians in Precision Agriculture	Occupations related to Traditional Engineering, Transportation Organizers, Safety and Compliance Managers

*Source:* Green Skills (Vona et al., 2015)

Green technology includes environmentally friendly solutions that set new usability and sustainability standards, as well as improved physical and financial efficiency when compared to traditional businesses, and incorporates green functions for long-term business survival (United Nations, 2019) [28]. Green technology adaptation includes industrial emissions reduction, recycling activities, wastewater management and treatment, self-sufficient buildings, converting waste particles to energy, wave energy generation, hybrid vehicles, solar energy application, vertical gardens and farms, and natural gas boilers. Green technology innovation gives us the best chance of mitigating the effects of climate change and pollution. Natural resources are limited; in many cases, the majority of the resources have been depleted or consumed. These resources are divided into two categories: renewable energy and non-renewable energy. Non-renewable sources of energy include nuclear, natural gas, fuel, coal, and hydrogen. Hydro, wind, geothermal, and biomass are examples of renewable energy sources that have enormous potential to be used as limitless resources to improve our quality of life (Koh & Ammar, 2019) [28].

Kamis et al. (2017) conducted a study that emphasised the importance of incorporating green skills and green technology into TVET programmes to contribute to sustainable development. Green skills and technology provide competent labour that can

act as a sustainable development agent by protecting and conserving environmental, economic, and social activities for skilled workforce development. Pavlova (2018) [29] emphasised the importance of implementing green skills and technology in the TVET system and skill development in response to government policy, reducing climate change, and providing new employment opportunities for novice workers. As a result, TVET programmes interact with green skills integration and green technology by exploring the skill set required for sustainable development by establishing, sustaining, adapting, and implementing new environmental industries, services, and practises in the context of developing a holistic approach.

According to Mustapha (2015) [30], the issues of green economic integration can be overcome by evolving TVET in Asia by developing the green mindset, green financial, green training, green education, green lifestyle, green sustainability, and green employability by ensuring that countries' policies, best practises, and limitations are corrected and resolved for continuous business, industry, and social development. Ramli et al. (2018) [31] agreed with Mustapha's research on the importance of incorporating green skills for sustainable development by emphasising green technology. During the fourth industrial revolution, competent individuals, green economic education and skills, and social and environmental factors were ideal. TVET is critical in promoting the development of a sustainable workforce by educating and training students through a more fantastic sustainability-related curriculum. In order to achieve the fourth industrial revolution, these efforts must also combat poverty and promote equitable economic growth.

Thirupathy and Mustapha (2020) [32] argue that understanding our actions towards the environment necessitates a high level of awareness. Students must be educated on the negative effects of irresponsible behaviour on the environment. Environmental sustainability beliefs and skills should be taught together so that educational institutions can produce employees who are more than just knowledgeable. Yeung (2015) [33] discussed how positive mindset can improve students' positive thinking and transversal competence as part of their lifelong learning skills. As a result, this study identifies the mindset and awareness of TVET students and educators in a public higher education institution regarding green skills.

Furthermore, green attitudes are being identified in this study. Green attitudes, according to Samarasinghe (2015) [34], are individuals' intentions to apply norms related to green skills in the form of encouragement, attention, response, resources, and relevant aspects. This study determines the green skills competency of TVET students and educators, in addition to their green attitudes. According to Jordan et al. (2012) [35], if implemented effectively, competency-based education can improve quality and consistency, reduce costs, shorten the time required to graduate, and provide accurate assessments of student learning and educators' teaching. Green competencies, according to Cabral and Dhar (2020) [36], are a comprehensive construct that includes green knowledge, skills, abilities, attitudes, behaviours, and awareness.

Majumdar (2010) [37] identified five dimensions for greening the TVET framework through green elements at the institutional level. Greening TVET is regarded as one of the holistic frameworks for a smooth transition of the TVET sector to a sustainable and low-carbon environment. A proposed framework based on five green elements is intended to embed concepts of sustainable development in TVET institutions (Setiawan, 2017) [38]. Green campus, green curriculum, green research, green community, and green culture are the five elements. These five elements align with this study in determining

## A SURVEY OF FACILITY MANAGEMENT GREEN SKILLS COMPETENCY AMONG TVET EDUCATORS AND STUDENTS IN A PUBLIC UNIVERSITY IN MALAYSIA

green elements in the TVET curriculum based on the perspectives of TVET students and educators.

The purpose of this study is to identify green skills competency among Agriculture, Engineering Technology, and Family and Consumer Sciences students and educators in a public higher education institution as a case study. Green skills constructs derived from this case study include mindset and awareness, attitude, competency, green elements in the TVET curriculum, green integration during teaching practice, and competency in green technology. As an initial study, this case study is carried out in a public higher educational institution. The findings of this study are expected to provide guidance for future in-depth and extensive research.

### Purpose and Objectives of the Study

This study aims to identify the green skills competency among TVET educators and students in a public higher educational institution. Specifically, the objectives of this study are as follows:

RO1: To identify the respondents' ideas about green skills and green technology.

RO2: To identify barriers faced while engaging in teaching and learning green skills.

RO3: To provide suggestions to enhance green skills competency among respondents.

### Research Questions

Several issues were identified through this case study related to green skills competency among Agriculture, Engineering Technology and Family and Consumer Sciences programmes in Faculty of Technical and Vocational students and educators in a public higher educational institution's Faculty of Technical and Vocational. The issues examined are as the following:

RQ1: What are the respondents' ideas about green skills and green technology?

RQ2: What are the barriers faced while engaging in teaching and learning green skills?

RQ3: What are the suggestions to enhance green skills competency among respondents?

### Conceptual Framework

The purpose of this study is to identify green skills competency among TVET educators and students from a selected higher educational institution's Faculty of Technical and Vocational Agriculture, Engineering Technology, and Family and Consumer Sciences programmes. The conceptual framework of the study is developed using relevant theories and models. The green skills competency (Pavlova, 2017) [39] and ecological modernization theory (Howes et al., 2010) are used as theoretical frameworks in this study. According to Pavlova (2017) [39], integrating TVET education with the nature of green skills/competencies contends the development of the green economy. Many regions and countries see significant holistic integration of the environment and development recognition as a future-oriented approach. As a result, green skills should be considered essential competencies for inclusion in TVET education. It is critical to place a special emphasis on developing values and attitudes in order to achieve greening. As a result, competence-based training should be broadened on occasion. Individuals and societies could improve students' general understanding of environmental concerns and develop their readiness for green restructuring if vocational and professional education programmes were realigned to meet the current and future demands of a greener economy.

According to Abd Hamid et al. (2019) [40], when most people hear the word "green," they immediately think of the environment and exhibit generic green skills and actions.

Unlike generic skills, generic green skills have received little attention. Higher education students regard education as the most exemplary medium for sharing knowledge, experience, awareness, and practise of general green skills. Generic green skills are additional skills that focus on protecting, conserving, and sustaining a beautiful environment, in addition to the generic skills that have already been established. Through teaching and learning practises, general green skills will be instilled in future manpower employability, particularly in the green labour marketplace. Educators and students in higher education must be aware of generic green skills and be able to apply them effectively. More research is required to identify more specifics and explicit general green skills implementation concepts among educators and university students.

Howes et al. (2010) [41] emphasised ecological modernization theory (EM), which states that economic development can be separated from environmental impact through a variety of technological and institutional innovations. As a result, EM is a significant theory chosen for the study due to its significant impact on environmental policy, planning, and management systems in many industrialised nations over the previous two decades. EM transforms science and technology by serving as both a cause and a solution to environmental problems. These innovations can be realised by replacing polluting materials with more sustainable alternatives, improving resource use effectiveness through waste and recycling minimization, and shifting the proportion of production away from resource-intensive and towards those that cause less environmental damage. The goal is to incorporate community feedback mechanisms into institutions' power in order to better connect decision-makers with communities. EM has three major advantages. The first is to promote a more holistic approach to environmental concerns by conceptually linking ecological goals with other policy domains. Second, EM helps to achieve the widely acknowledged policy goal of sustainable development. Third, it may create change initiatives that positively engage with the power of existing institutions.

As a result, the main construct in this study was green skills competency for TVET students and educators. Green skills mindset and awareness, green attitude, competency in saving/alternative energy, water conservation, 3R waste management skills, green curriculum, green landscaping skills and energy-saving technologies, green elements in TVET curriculum, green integration during teaching practise, and competency in green technology are all part of this competency. Demographic factors such as age, gender, respondents' category, and programmes were selected.

## **2. Methods**

In this study, third- and fourth-year undergraduate students and teachers from the Engineering Technology, Agriculture, and Family and Consumer Science programmes in the Faculty of Technical and Vocational of a public university were assessed for their proficiency in green skills.

The research design used in this study is a case research method in single side and multiple cases. A case study is an empirical investigation that examines a current phenomenon within its actual setting, particularly when the distinctions between phenomenon and setting depend on several sources of information. This definition was provided by Yin (1994) [42]. As Yin pointed out, if someone wants to purposefully analyse contextual conditions, they should employ a case study technique. A case study, according to Gomm, Hammersley, and Foster (2000) [43], is research that examines a small number of cases in great detail.

**A SURVEY OF FACILITY MANAGEMENT GREEN SKILLS COMPETENCY AMONG  
TVET EDUCATORS AND STUDENTS IN A PUBLIC UNIVERSITY IN MALAYSIA**

Cherry (2020) [44] asserts that a case study focuses on the factual or opinion information of respondents and is a generally regarded method for gathering information and describing the existence of a phenomenon. The architecture of the case study makes it possible to collect a lot of data quickly. Through this design, data about demographics, experiences, views, and hypothetical situation can be gathered. A questionnaire is used in this study as an instrument to gather pertinent information regarding green skills competency. In addition, open-ended questions were embedded at the end of the questionnaire.

The open-ended questions typically focus on "how or why" a phenomenon occurred in a real-life setting. According to Jones et al. (2013) [47], the instrument used to collect the data should take into account the qualitative aspect.

The respondents in this study consisted of two groups. A group of 81 third- and fourth-year undergraduate students were chosen from the Engineering Technology, Agriculture, and Family and Consumer Science programmes and 40 educators were selected.

There are ten open-ended questions in this part designed to elicit information about the respondents' suggestions regarding green skills competency. Respondents must express their suggestions by answering the open-ended questions from No. 94 to No. 103. Table 3 lists the ten open-ended questions developed in this part. Open-ended items were categorized by using the thematic analysis technique. The results are tabulated in table form using frequency, percentage, mean, and standard deviation. Braun and Clarke (2006) [54] used theme analysis to evaluate open-ended data. Section C contained open-ended items meant to study students' and educators' ideas about green skills and green technology

TABLE 1 DISTRIBUTION OF THE QUESTIONNAIRE ITEMS IN SECTION C

No.	Item
94.	Provide a brief definition of green skills according to your knowledge.
95.	Have you ever attended any course/seminar/training about green skills?
96.	How would you rate your green knowledge?
97.	How would you rate your green skills competency?
98.	List 3 benefits of green technology.
99.	List 3 benefits of green skills competency among TVET students.
100.	List 3 barriers you have faced while teaching green skills in your institution.
101.	Provide 3 suggestions to your institution to enhance green skills competency among TVET educators.
102.	Provide 3 suggestions to your institution to enhance green skill competency among TVET students.
103.	State any comments related to this survey (if any).

### 3. Results and Analysis

Ten open-ended questions have been constructed in this study. Discussion in this chapter was based on several themes derived from the students' and educators' answers to the open-ended items in the questions based on thematic analysis.

Following the thematic analysis, nine themes for the first open-ended item had been identified. Braun and Clarke (2006) [54] mentioned that thematic analysis was used to categorized the results of the open-ended items. The following tables display the responses of 81 students and 40 educators to open-ended questions on the definition of green skills. As indicated in Table 4, the qualitative data from the first open item may be divided into six themes namely sustainability, knowledge of green technology, recycling



**A SURVEY OF FACILITY MANAGEMENT GREEN SKILLS COMPETENCY AMONG TVET EDUCATORS AND STUDENTS IN A PUBLIC UNIVERSITY IN MALAYSIA**

activities, knowledge of green jobs, non-renewable and non-renewable resources and green curriculum.

**TABLE 4 OPEN-ENDED ITEM ABOUT MEANING/DEFINITION OF GREEN SKILLS (STUDENTS)**

Item	Theme	Frequency ( <i>f</i> )
Provide a brief definition of green skills according to your knowledge	Sustainability of economy, environment and human activities	26
	Knowledge of Green Technology	24
	Recycling activities	16
	Knowledge of Green Jobs	7
	Renewable and non-renewable resources	2
	Green Curriculum	1

Brief definition of green skills according to educators' knowledge is presented through Table 5. Six themes were extracted from the definition provided, namely promoting environmental sustainability as the highest frequency, enhancing quality of life, encouraging recycling, related to green technology, opportunities to engage in green jobs and associated with renewable energy, green products, research and development as the least obtained.

**TABLE 5 OPEN-ENDED ITEM ABOUT MEANING/DEFINITION OF GREEN SKILLS EDUCATORS)**

Item	Theme	Frequency ( <i>f</i> )
Provide a brief definition of green skills according to your knowledge	Promote environmental sustainability	15
	Enhances quality of life	10
	Promotes recycling	7
	Related to green technology	7
	Opportunities of engaging in Green Jobs	3
	Related to renewable energy, green products and, research and development	2

The next item required students to response regarding their engagement in course/seminar/training about green skills. Figure 4 shows that only 21 percent of the educators attended course/seminar/training about green skills. Large group of students, 79 percent of the them are yet to attend course/seminar/training.

Pernahkah anda menghadiri kursus / seminar / latihan berkenaan kemahiran hijau?  
81 responses

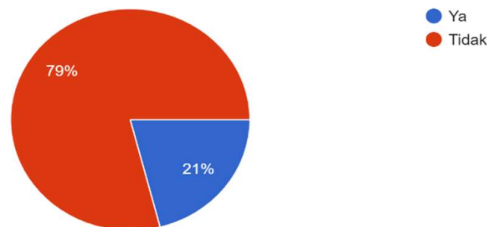

Figure 4. Percentage of students engaged in courses/seminar/training about green skills.

Figure 5 shows that 37.5 percent of the educators attended course/seminar/training about green skills. However, another 62.5 percent of the educators are yet to attend course/seminar/training.

**A SURVEY OF FACILITY MANAGEMENT GREEN SKILLS COMPETENCY AMONG TVET EDUCATORS AND STUDENTS IN A PUBLIC UNIVERSITY IN MALAYSIA**

Have you ever attended any course / seminar / training about green skills?  
40 responses

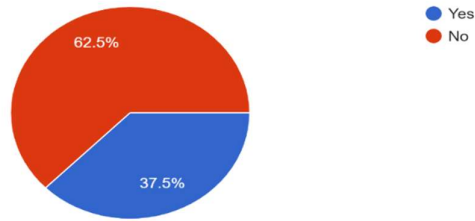

Figure 5. Percentage of educators engaged in courses/seminar/training about green skills.

Figure 6 shows that 7.4 percent of students rated very good, 69.1 percent of students had rated good, 21 percent rated poor and 2.5 percent very poor on their green skills knowledge. Majority of the students acquired good knowledge in average regarding green skills knowledge.

Apakah tahap pengetahuan hijau anda?  
81 responses

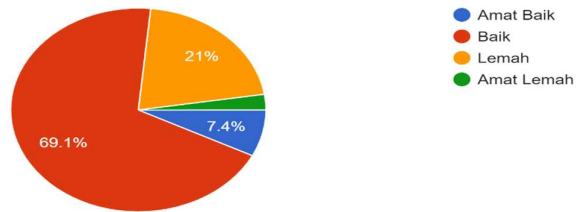

Figure 6. Percentage of students rating their green knowledge.

Whereby, Figure 7 shows that 15 percent of educators rated very good, 52.5 percent had rated good, 25 percent rated poor and 7.5 percent very poor on their green skills knowledge. Majority of the students acquired good knowledge in average regarding green skills knowledge.

How would you rate your green knowledge?  
40 responses

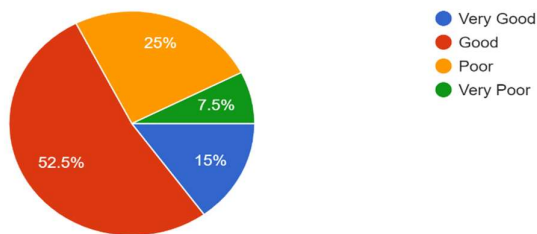

Figure 7. Percentage of educators rating their green knowledge.

**A SURVEY OF FACILITY MANAGEMENT GREEN SKILLS COMPETENCY AMONG TVET EDUCATORS AND STUDENTS IN A PUBLIC UNIVERSITY IN MALAYSIA**

Figure 8 presents students rate about their green skills competency. From the chart, 6.2 percent of students possess very good green skills competency. Majority of the students rated they possess good green skills competency which recorded 72.8 percent. Only 19.8 percent of students are poor and 1.2 percent very poor in green skills competency.

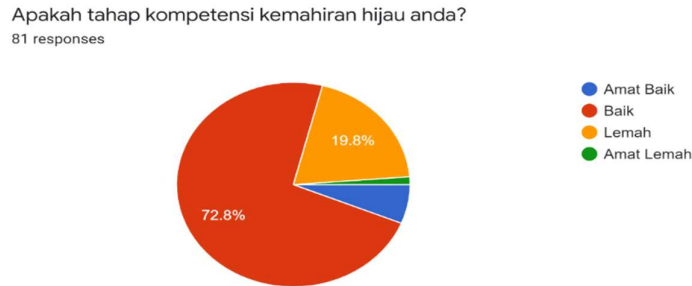

Figure 8. Percentage of students rating their green skills competency.

Figure 9 indicates educators rating on their green skills competency with 2.5 percent possess very good competency. There are 47.5 percent of educator good in green skills competency, 40 percent poor and 10 percent very poor.

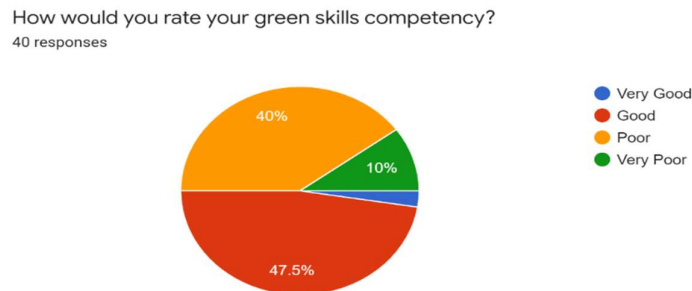

Figure 9. Percentage of educators rating their green skills competency

Table 6 shows the benefits of green technology are divided into six themes namely promoting sustainable environment, encouraging recycling activities, enables energy saving, promoting quality of life, green technology adoption and promoting green economy. As each student had to provide three benefits, frequency of the promoting sustainable environment seems to be the highest.

TABLE 6. OPEN-ENDED ITEM ABOUT BENEFITS OF GREEN TECHNOLOGY (STUDENTS)		
Item	Theme	Frequency ( <i>f</i> )
List 3 benefits of green technology	Promoting sustainable environment	73
	Encouraging recycling activities	38
	Enables energy saving	37
	Promoting quality of life	32
	Green technology adoption	32
	Promoting green economy	5

**A SURVEY OF FACILITY MANAGEMENT GREEN SKILLS COMPETENCY AMONG  
TVET EDUCATORS AND STUDENTS IN A PUBLIC UNIVERSITY IN MALAYSIA**

Table 7 highlights about the benefits of green technology responded by the educators. There are eight themes derived, namely managing and maintaining sustainable environment, relate with renewable energy, promoting recycling activities, saving operational costs, improving wellbeing, enhancing energy saving, providing more green jobs opportunities and encouraging use of green materials. Each educator had to provide three benefits, hence, the frequency of managing and maintaining environment had been prioritized.

**TABLE 7 OPEN-ENDED ITEM ABOUT BENEFITS OF GREEN TECHNOLOGY (EDUCATORS)**

Item	Theme	Frequency ( <i>f</i> )
List 3 benefits of green technology	Manage and maintain sustainable environment	21
	Related to renewable energy	9
	Promotes recycling activities	8
	Saves operational cost	7
	Promotes well being	7
	Promotes energy savings	5
	Green job opportunities	5
	Encourages use of green material	2

Based on Table 8, seven themes were derived related to benefits of green skills competency among students. The themes are green related research and development, promoting wellbeing, sustainable green technology, green elements integration in students' educational activities, new product development through recycling activities, renewable energy adoption to save energy and future green job skills set. Students had highlighted the green related research and development are the most essential benefit of green skills competency.

**TABLE 8 OPEN-ENDED ITEM ABOUT BENEFITS OF GREEN SKILLS COMPETENCY AMONG  
STUDENTS (STUDENTS)**

Item	Theme	Frequency ( <i>f</i> )
List 3 benefits of green skills competency among students	Green related research and development	59
	Promoting wellbeing	41
	Sustainable green technology	36
	Green elements integration in students' educational activities	25
	New product development through recycling activities	24
	Renewable energy adoption to save energy	22
	Future green job skills set	12

As for Table 9, educators responded for open-ended item about listing three benefits of green skills competency among TVET students and six themes were derived from the responses. The themes are enhancing green knowledge as the most popular benefit among educators. Followed by preparing students for green jobs opportunities, fostering awareness and practices in green skills, promoting recycling activities, adopting value added technology and encouraging cost saving operations toward sustainable environment as the least important benefit.

**A SURVEY OF FACILITY MANAGEMENT GREEN SKILLS COMPETENCY AMONG  
TVET EDUCATORS AND STUDENTS IN A PUBLIC UNIVERSITY IN MALAYSIA**

TABLE 9 OPEN-ENDED ITEM ABOUT BENEFITS OF GREEN SKILLS COMPETENCY AMONG  
STUDENTS (EDUCATORS)

Item	Theme	Frequency ( <i>f</i> )
List 3 benefits of green skills competency among TVET students	Enhance green knowledge	17
	Preparing students for green jobs	13
	Foster awareness and practice in green skills	9
	Promotes recycling	5
	Adopt value added technology	3
	Encourages cost saving operations towards sustainable environment	2

Table 10 presents barriers faced by students while learning green skills in the faculty. Five themes were classified namely, lack of educators to deliver green skills related curriculum, inadequate infrastructure to support green skills related activities, training needs to uplift green skills competency, financial issues in carrying out green skills related activities and lack of motivation engaging in green skills related activities. Majority students indicated that lack of educators to deliver green skills related curriculum as the most critical barrier faced while learning green skills in the faculty.

TABLE 10 OPEN-ENDED ITEM ABOUT BARRIERS FACED WHILE LEARNING GREEN SKILLS  
IN THE FACULTY (STUDENTS)

Item	Theme	Frequency ( <i>f</i> )
List 3 barriers faced while learning green skills in the faculty	Lack of educators to deliver green skills related curriculum	51
	Inadequate infrastructure to support green skills related activities	48
	Training needs to uplift green skills competency	48
	Financial issues in carrying out green skills related activities	12
	Lack of motivation engaging in green skills related activities	9

Educators listed three barriers faced while teaching green skills in their institution, shown in Table 11. Four themes were derived with the most challenging barrier is inadequate facilities to support green skills related activities. Next, educators also highlighted lack of knowledge about green skills as the second challenging factor. Educators further listed need to emphasize on practical knowledge and lack of motivation as the other barriers faced while teaching green skills.

TABLE 11 OPEN-ENDED ITEM ABOUT BARRIERS FACED WHILE LEARNING GREEN  
SKILLS IN THE FACULTY (EDUCATORS)

Item	Theme	Frequency ( <i>f</i> )
List 3 barriers faced while teaching green skills in your institution	Inadequate facilities to support green skills related activities	22
	Lack of knowledge in green skills	21
	Need to emphasize on practical knowledge	6
	Lack of motivation	4

**A SURVEY OF FACILITY MANAGEMENT GREEN SKILLS COMPETENCY AMONG  
TVET EDUCATORS AND STUDENTS IN A PUBLIC UNIVERSITY IN MALAYSIA**

According to Table 12, several suggestions were provided by students for the institution to enhance green skills competency. Six themes were categorized include should provide more green skills related training, promote green related activities and curriculum, engage students in green related real-life job-related practical learning, provide adequate infrastructure for green skills learning, involve relevant stakeholders in uplifting green skills competency and promote green technology utilization. Among the themes, students had highlighted the need for green skills related training to enhance green skills competency.

TABLE 12 OPEN-ENDED ITEM ABOUT SUGGESTIONS TO INSTITUTION TO ENHANCE  
GREEN SKILLS COMPETENCY (STUDENTS)

Item	Theme	Frequency ( <i>f</i> )
Provide 3 suggestions to your institution to enhance green skills competency	Should provide more green skills related training	59
	Should promote green related activities and curriculum	43
	Should engage students in green related real-life job-related practical learning	33
	Should provide adequate infrastructure for green skills learning	30
	Should involve relevant stakeholders in uplifting green skills competency	21
	Should promote green technology utilization	8

Table 13 highlights suggestions made by educators to the institution to enhance green skills competency among TVET educators and students. Five themes were classified. The educators had emphasized on the need to conduct seminar and training related to green skills as the top suggestion. Followed by need to restructure green curriculum, ensuring adequate resources are available, cultivating green attitude and ensuring policy is implemented in institutional and national level.

TABLE 13 OPEN-ENDED ITEM ABOUT SUGGESTIONS TO INSTITUTION TO ENHANCE  
GREEN SKILLS COMPETENCY (EDUCATORS)

Item	Theme	Frequency ( <i>f</i> )
Provide 3 suggestions to your institution to enhance green skills competency among TVET educators and students	Emphasizing on seminar and training	24
	Need to restructure green curriculum	15
	Ensure adequate resources are available	7
	Cultivate green attitude	6
	Ensure policy is implemented in institutional and national level	6

Table 14 shows the final open-ended item which had made the students to provide any other related comments about this survey. Two themes only were classified, namely need to have a specific platform for students to lift up their green skills and green technology competency with the highest frequency. Followed by the need to create a new curriculum to expose and train students with green skills and green technology related TVET practical knowledge, related to this survey.

**A SURVEY OF FACILITY MANAGEMENT GREEN SKILLS COMPETENCY AMONG  
TVET EDUCATORS AND STUDENTS IN A PUBLIC UNIVERSITY IN MALAYSIA**

TABLE 14 OPEN-ENDED ITEM ABOUT ANY COMMENTS ABOUT THIS SURVEY (STUDENTS)

Item	Theme	Frequency ( <i>f</i> )
State any comments related to this survey (if any)	Need to have a specific platform for students to lift up their green skills and green technology competency	5
	Need to create a new curriculum to expose and train students with green skills and green technology related TVET practical knowledge	4

Table 15 shows additional comments provided by the educators pertaining to this survey. Two themes were categorized with the most frequently highlighted comment is about the need for emphasizing on green knowledge and practices, followed by comment about greening TVET and awareness creating pertaining to green skills competency.

TABLE 15 OPEN-ENDED ITEM ABOUT ANY COMMENTS ABOUT THIS SURVEY  
(EDUCATORS)

Item	Theme	Frequency ( <i>f</i> )
State any comments related to this survey (if any)	Emphasizing on green knowledge and practices	8
	Comment about greening TVET and awareness creation	5

Open-ended questions were analyzed through thematic analysis and the findings has been reported through the tables for students and educators accordingly. Based on the thematic analysis, students had highlighted that promoting sustainable economy with environmentally friendly intervention as the most important aspect of green skills competency. Besides that, they also indicated the importance of engaging in recycling activities, enabling energy saving and improvisation of wellbeing. Educators had emphasized on enhancing green knowledge, manage and maintain sustainable environment and preparing students for green jobs demand as the most important aspects of green skills competency.

#### 4. Conclusion

The findings of the study show several significant patterns and main trends. When asked about the respondents' understanding of the green concept, the findings revealed six main categories – sustainability, knowledge of green technology, recycling activities, knowledge of green jobs, non-renewable and non-renewable resources and green curriculum.

Most of the participants agreed that they possessed green knowledge and skills. They also stated the benefits of green technology which included creating sustainable environment, providing renewable energy, promoting recycling activities, saving operational costs, improving wellbeing, enhancing energy saving, providing more green jobs opportunities and encouraging the use of green materials.

However, the most challenging barrier is inadequate facilities to support green skills related activities. Next, educators also highlighted the lack of proper green curriculum and the lecturers lack of motivation as the other barriers faced while teaching green skills.

Finally, the respondents made suggestions to their institution on how to enhance green skills competency among TVET educators and students. Five themes emerged. The educators had emphasized on the need to conduct seminar and training related to green skills as the top suggestion. Followed by need to restructure green curriculum, ensuring



adequate resources are available, cultivating green attitude and ensuring policy is implemented at the institutional and national levels.

## 5. References

- [1] IFMA. (2022). What is Facility Management. International Facility Management Association. <https://www.ifma.org/about/what-is-facility-management/>
- [2] Michel. (n. d.). Facility Management is About More Than Just The Physical Elements. FM Insight Consulting Ltd. <http://facilityleadership.com/blog/management-and-leadership/facility-management-is-about-more-than-just-the-physical-elements>
- [3] Abdullahi, I., & Yusoff, W. Z. W. (2018). Effect of the performance of physical and non-physical facilities on higher institutional facilities. *Journal of Facilities Management*.
- [4] IWFM. (2022). Professional Development. Institute of Workplace and Facilities Management. <http://www.iwfm.org.uk>
- [5] Isa, N. M., Kamaruzzaman, S. N., Mohamed, O., Jaapar, A., & Asbollah, A. Z. (2016). Facilities management practices in Malaysia: a literature review. In *MATEC Web of Conferences* (Vol. 66, p. 00054). EDP Sciences.
- [6] Keeping, M. & Shiers, D. (1996). The "green" refurbishment of commercial property. *Facilities*, 15-19.
- [7] Cant, M. (2004). Collaboration in infrastructure services in regional retail centres: Value-added contribution of facilities management at Birmingham Bullring. *Journal of Facilities Management*, 215-225.
- [8] Sustainability. (2014). Executive Perspective: The Business of Building Green – Singapore's Approach.
- [9] Wang, S., Wan, J., Li, D. & Zhang, C. (2016). Implementing Smart Factory of Industries 4.0: An Outlook. vol. 2016.
- [10] Weyer, S., Schmitt, M., Ohmer M. & Gorecky, D. (2015). Standardization as the crucial challenge for highly modular, multi - vendor production systems. *IFAC-Papers On Line*, vol. 48, no. 3, pp. 579 –584.
- [11] Kamis, A., Alwi, A., & Yunus, F. A. (2017). Integration of green skills in sustainable development in technical and vocational education. *International Journal of Engineering Research and Applications*, 7, 2248-962208.
- [12] Mertineit, K. D., & Huyen, D. T. (2016). Greening TVET in Viet Nam: sustainable development, green economy, and the role of greening TVET.
- [13] Ramlee, M., Irdyanti, M. N. & Nurul Nazirah, M. I. M. (2019). Awareness of Green Technology among Engineering Technology Students. *Journal of Engineering Science and Technology*, (Special Issue on ICEES2018), 1-8. [https://jestec.taylors.edu.my/Special%20issue%20on%20ICEES2018/ICEES2018\\_01.pdf](https://jestec.taylors.edu.my/Special%20issue%20on%20ICEES2018/ICEES2018_01.pdf)
- [14] United Nations. (2015). The 17 Goals. Department of economic and Social Affairs Sustainable Development. <https://sdgs.un.org/goals>
- [15] UNESCO. (2016). Strategy for Technical and Vocational Education and Training (TVET) (2016-2021). United Nations Educational Scientific and Cultural Organization. France. <https://unesdoc.unesco.org/ark:/48223/pf0000245239/PDF/245239eng.pdf.multi>

**A SURVEY OF FACILITY MANAGEMENT GREEN SKILLS COMPETENCY AMONG  
TVET EDUCATORS AND STUDENTS IN A PUBLIC UNIVERSITY IN MALAYSIA**

- [16] Pavlova, M. (2014). TVET as an Important Factor in Country's Economic Development. *SpringerPlus*, 3(1), 1-2. <https://springerplus.springeropen.com/articles/10.1186/2193-1801-3-S1-K3>
- [17] UNEVOC Network. (2019). Green Skills for SDGs. Generic Green Skills for TVET. <https://greenskillsresources.com/category/green-skills-for-sdgs>
- [18] European Commission. (2021). Employment, Social Affairs & Inclusion. Centres of Vocational Excellence. European Union. <https://ec.europa.eu/social/main.jsp?catId=1501#:~:text=Centres%20of%20Vocational%20Excellence%20are,the%20skills%20needs%20of%20companies.>
- [19] 3LoE. (2021). Three-Level Centres of Professional Excellence: Qualification, Entrepreneurship and Innovation in the Green Economy. European Union. <https://3-loe.eu/>
- [20] KeTTHA. (2017). Green Technology Master Plan Malaysia 2017-2030. Ministry of Energy, Green Technology and Water. <https://www.pmo.gov.my/wp-content/uploads/2019/07/Green-Technology-Master-Plan-Malaysia-2017-2030.pdf>
- [21] The Edge Market. (2021). The Twelfth Malaysia Plan 2021-2025: A Prosperous, Inclusive and Sustainable Malaysia. The Edge Communications Sdn. Bhd. <https://www.theedgemarkets.com/microsite/12-malaysia-plan>
- [22] Kamis, A., Mustapha, R., Wahab, N. A., & Ismail, B. L. H. (2016). Green Skills as an added-value element in producing competent students. *International Journal of Engineering Research and Applications*, 6(11), 12-21.
- [23] LinkedIn. (2022). Global Green Skills Report 2022. <https://economicgraph.linkedin.com/content/dam/me/economicgraph/en-us/global-green-skills-report/global-green-skills-report-pdf/LI-Green-Economy-Report-2021-land-R9.pdf>
- [24] Ismail, J. Bin, Chik, C. T., & Hemdi, M. A. (2021). TVET Graduate Employability: Mismatching Traits Between Supply and Demand. *International Journal of Academic Research in Business and Social Sciences*, 11(13), 223–243. [https://hrmars.com/papers\\_submitted/8522/tvet-graduate-employability-mismatching-traits-between-supply-and-demand.pdf](https://hrmars.com/papers_submitted/8522/tvet-graduate-employability-mismatching-traits-between-supply-and-demand.pdf)
- [25] Da Wan, C., Sirat, M., & Razak, D. A. (2018). Education in Malaysia towards a developed nation.
- [26] Vona, F., Marin, G., Consoli, D., & Popp, D. (2015). Green skills (No. w21116). National Bureau of Economic Research. [https://www.nber.org/system/files/working\\_papers/w21116/w21116.pdf](https://www.nber.org/system/files/working_papers/w21116/w21116.pdf)
- [27] United Nations. (2019). The Future is Now: Science for Achieving Sustainable Development. Department of economic and Social Affairs. [https://sustainabledevelopment.un.org/content/documents/24797GSDR\\_report\\_2019.pdf](https://sustainabledevelopment.un.org/content/documents/24797GSDR_report_2019.pdf)
- [28] Koh, K. S., & Ammar, S. B. M. F. (2019). An overview of renewable and non-renewable energy demand as well as development status in Malaysia. *Chem Sci Biomol Eng*, 1(1), 101.
- [29] Pavlova, M. (2018). Fostering inclusive, sustainable economic growth and “green” skills development in learning cities through partnerships. *International Review of Education*, 64(3), 339-354. <https://link.springer.com/article/10.1007/s11159-018-9718-x>
- [30] Piaw, C. Y. (2008). *Asas statistik penyelidikan*. Mc-Graw Hill (Malaysia).

A SURVEY OF FACILITY MANAGEMENT GREEN SKILLS COMPETENCY AMONG  
TVET EDUCATORS AND STUDENTS IN A PUBLIC UNIVERSITY IN MALAYSIA

- [31] Ramlee, M. (2015). Green and Sustainable Development for TVET in Asia. *Innovation of Vocational Technology Education*, 11(2). doi:10.17509/invotec.v11i2.2147  
<https://ejournal.upi.edu/index.php/invotec/article/view/2147/1510>
- [32] Ramli, S., Rasul, M. S., & Affandi, H. M. (2018). Sustainable Development: Needs of Green Skills in the Fourth Industrial Revolution (4IR). *International Journal of Academic Research in Business and Social Sciences*, 8(9), 1082–1095. <https://pdfs.semanticscholar.org/33f8/2cd37a6c0ae93211e85705ea17518e176a0a.pdf>
- [33] Thirupathy, S., & Mustapha, R. (2020). Development of Secondary School Students' Green Skills for Sustainable Development. *International Journal of Academic Research in Business and Social Sciences*, 10(3), 160–173. [https://hrmars.com/papers\\_submitted/7032/development-of-secondary-school-students-green-skills-for-sustainable-development.pdf](https://hrmars.com/papers_submitted/7032/development-of-secondary-school-students-green-skills-for-sustainable-development.pdf)
- [34] Yeung, S. M. C. (2015). A mindset of entrepreneurship for sustainability. *Corporate Ownership and Control*, 13(1CONT 7), 797-811. [http://www.virtusinterpress.org/IMG/pdf/COC\\_Volume\\_13\\_Issue\\_1\\_Fall\\_2015\\_Continued7\\_.pdf#page=71](http://www.virtusinterpress.org/IMG/pdf/COC_Volume_13_Issue_1_Fall_2015_Continued7_.pdf#page=71)
- [35] Samarasinghe, R. (2015). Green Attitudes And Behavior Gap; Obstruction To Be Green. <http://dr.lib.sjp.ac.lk/bitstream/handle/123456789/6656/Green%20Attitudes%20And%20Behavior%20Gap;%20Obstruction%20To%20Be%20Green.pdf?sequence=1>
- [36] Jordan, C., Doherty, W. J., Jones-Webb, R., Cook, N., Dubrow, G., & Mendenhall, T. J. (2012). Competency-based faculty development in community-engaged scholarship: A diffusion of innovation approach. *Journal of Higher Education Outreach and Engagement*, 16(1), 65-95. <https://files.eric.ed.gov/fulltext/EJ975801.pdf>
- [37] Cabral, C., & Dhar, R. L. (2020). Green competencies: Insights and recommendations from a systematic literature review. *Benchmarking: An International Journal*. <https://www.emerald.com/insight/content/doi/10.1108/BIJ-11-2019-0489/full/html>
- [38] Majumdar, S. (2010) Greening TVET: Connecting the Dots in TVET for Sustainable Development. Paper presented in the 16th IVETA-CPSC International Conference on Education for Sustainable Development in TVET' Manila, Philippines.
- [39] Setiawan, A. (2017). Identification of green skills acquisition in Indonesian TVET curricula. In *AIP Conference Proceedings* (Vol. 1887, No. 1, p. 020074). AIP Publishing LLC. <https://aip.scitation.org/doi/pdf/10.1063/1.5003557>
- [40] Pavlova, M. (2017). Green skills as the agenda for the competence movement in vocational and professional education. In *Competence-based Vocational and Professional Education* (pp. 931-951). Springer, Cham. [https://link.springer.com/chapter/10.1007/978-3-319-41713-4\\_43](https://link.springer.com/chapter/10.1007/978-3-319-41713-4_43)
- [41] Abd Hamid, M. Z., Hassan, Z., Nordin, M. S., Kamin, Y., Atan, N. A., & Suhairom, N. (2019). Generic Green Skills in Teaching and Learning: Meaning and Implementation. *Universal Journal of Educational Research*, 7(12A), 121-126.

**A SURVEY OF FACILITY MANAGEMENT GREEN SKILLS COMPETENCY AMONG  
TVET EDUCATORS AND STUDENTS IN A PUBLIC UNIVERSITY IN MALAYSIA**

- [42] Howes, M., McKenzie, M., Gleeson, B., Gray, R., Byrne, J., & Daniels, P. (2010). Adapting ecological modernisation to the Australian context. *Journal of integrative environmental sciences*, 7(1), 5-21. [https://www.researchgate.net/publication/46062585\\_Adapting\\_Ecological\\_Moder\\_nisation\\_to\\_the\\_Australian\\_Context](https://www.researchgate.net/publication/46062585_Adapting_Ecological_Moder_nisation_to_the_Australian_Context)
- [43] Yin, R.K. (1994). Case Study Research – Design and Methods 2ND Edition. California, Sage Publications
- [44] Gomm, R., Hammersley, M., & Foster, P. (2000). Case study and generalization. *Case study method*, 98-115.
- [45] Cherry, K. (2020, April 7). When to Use Surveys in Psychological Research. Dotdash Media. <https://www.verywellmind.com/what-is-a-survey-2795787>
- [46] Ball, H. L. (2019). Conducting Online Surveys. *Journal of Human Lactation*, 35(3), 413-417.
- [47] Sincero, S. M. (2012). Advantages and Disadvantages of Surveys.
- [48] Jones, T. L., Baxter, M., & Khanduja, V. (2013). A Quick Guide to Survey Research. *Ann R Coll Surg Engl.* 95. 5-7. (<https://www.ncbi.nlm.nih.gov/pmc/articles/PMC3964639/pdf/rcse9501-5.pdf>)
- [49] Noraini Idris. (2010). Penyelidikan dalam Pendidikan. Kuala Lumpur. McGraw Hill (Malaysia) Sdn. Bhd.
- [50] Bhandari, P. (2020, May 14). Population vs Sample: Definitions, Differences & Examples.
- [51] Hashim, Y. A. (2010). Determining sufficiency of sample size in management survey research activities. *International Journal of Organisational Management & Entrepreneurship Development*, 6(1), 119-130.
- [52] Krejcie, R.V., & Morgan, D.W., (1970). Determining Sample Size for Research Activities. *Educational and Psychological Measurement*.
- [53] Wright, K. B. (2017). Researching Internet-Based Populations: Advantages and Disadvantages of Online Survey Research, Online Questionnaire Authoring Software Packages, and Web
- [54] Ben-Shlomo Y, Brookes S, Hickman M. 2013. Lecture Notes: Epidemiology, Evidence-based Medicine and Public Health (6th ed.), Wiley-Blackwell, Oxford.
- [55] Braun V. & Clarke V., 2006. Using thematic analysis in psychology. *Qualitative Research in Psychology* 3, pp.77-101. [www.QualResearchPsych.com](http://www.QualResearchPsych.com).
- [56] Ministry of Education Malaysia. (2013). Executive Summary Malaysia Education Blueprint 2013-2025: Preschool to Post-Secondary Education. <https://www.pmo.gov.my/wp-content/uploads/2019/07/Malaysia-Education-Blueprint-2013-2025.pdf>
- [57] Brundtland, G. H. (1987). Our common future. United Nation, General Assembly. Report of the World Commission on Environment and Development.
- [58] Hodges, C. P. (2005). A facility manager's approach to sustainability. *Journal of Facilities Management*. Vol. 3 No. 4, pp. 312-324.
- [59] IFMA. (2013). International Facility Management Association (IFMA). <http://www.ifma.org/about/what-is-facility-management>

## THE EVALUATION OF BUILDING ELECTRICAL INSTALLATION TRAINING PROGRAM AT THE BANDA ACEH WORK TRAINING CENTER (BLK)

**Habibuddion Muslihin, Sadrina, and Husnizar**

<sup>1</sup>Electrical Engineering Education Department, Teaching and Training Education  
Faculty, Banda Aceh Ar-Raniry Islamic University  
E-mail: sadrina@ar-raniry.ac.id

### **Abstract**

Vocational Training Center (BLK) is an institution that provides students with provisions in the form of: skills according to the needs of the world of work. The formulation of the problem in this study is how the success of the simple stage electrical installation training program V in 2021 at the Banda Aceh Job Training Center. The purpose of this research is to find out the success of the phase IV simple building electricity installation program in 2021 in Banda Aceh Vocational Training Center. The research method used is approach quantitative. Quantitative data was obtained from the questionnaire instrument which was then analyzed using descriptive statistics. The research was carried out in line with the Installation program training schedule simple building electricity in phase IV, July 2021. The training program lasts for 34 day in BLK location. The results of this study found that the BLK had organized Phase IV of the simple building electrical installation training program, which began in July 2021, has been completed successfully and effectively create qualified, professional, competent and well-behaved participants well after training.

**Keywords:** *vocational, Training centre, electricity*

### **1. Introduction**

Education as an effort to improve the quality of human resources (HR) to be a source of professional, quality and innovative. Education has become key It is important for the government's efforts to produce professional human resources. Education Informal aims to equip people with knowledge. In education this happens coaching education, training and development of the potential of students to fulfill personal survival and well-being in society.

The initial stage of the research began with making observations at the Vocational Training Center (BLK) Banda Aceh and conducted interviews with Building Electrical Installation Instructors Simple. After completing the interview, there were several problems in implementation of the Simple Building Electrical Installation training program, several problems faced today, forms of training that are open to the public and have no educational boundaries, has become the main problem faced by the participants of the Vocational Training Center who took part in training even though they have been interviewed for a commitment to join the training. However, in progress training there are some participants who break the rules and are not committed to learning. Another problem also arises, namely the training program at the BLK does not limit the requirements education so that there is an irregularity in the level of reasoning and absorption of the

**THE EVALUATION OF BUILDING ELECTRICAL INSTALLATION TRAINING PROGRAM  
AT THE BANDA ACEH WORK TRAINING CENTER (BLK)**

knowledge of the participants educate. Basically, students who take part in the BLK program come from different backgrounds different educational, social and cultural. Thus, a training approach or method is needed in accordance.

## **2. Literature Review**

- a. Program Evaluation  
Program evaluation is a design activity that is carried out intentionally aims to see a level of success of the program.
- b. Training  
Training is a process of structured learning experiences to improve knowledge, attitudes and skills.
- c. Electrical Installation  
Based on PUIL 2011, installation is an activity of installing or assembling it goods or networks. While the electrical installation is a system that is used to distribute electricity to meet human needs in life.
- d. Work Training Center  
The job training center is a regional technical unit that carries out some internal service tasks improve technical and operational capabilities as well as provide direct services to industrial society and the general public in the field of training.

## **3. Methodology**

The research method used is a quantitative approach. This approach is used to collect in-depth data and produce more comprehensive facts. So the focus of this research is to get complete and in-depth data, which is capable provide solutions to problems that will be examined with a research method approach quantitative. Quantitative data was obtained from the questionnaire instrument which was then analyzed using descriptive statistics.

This research was conducted at the Banda Aceh Training Center (BLK) and its implementation. Data collection techniques are the most strategic steps in research, because the main purpose of research is to get data. The technique used for collecting data in this study is distributing questionnaires. Questionnaire is a way from the process of collecting data obtained through answers to respondents' statements. Charging questionnaires or questionnaires carried out by participants in the building electrical installation training program simple at the Banda Aceh Vocational Training Center (BLK) stage IV June 2021.

The data analysis technique used in this research is descriptive analysis percentage. Descriptive analysis is considered capable of describing or giving an overview of sample or population as it is. Data analysis activities in this study include the stage of grouping the data to present the data according to the variable being measured, as well as performing calculations to answer the problem formulation. Data collected will be analyzed descriptive quantitative. Steps used to analyze the collected quantitative data:

- a. Make a distribution table for questionnaire answers
- b. Determine the score of the respondent's answer with the provisions of a predetermined score. The score assessment for each of the questionnaire answer choices that the respondent answered was as follows:

**THE EVALUATION OF BUILDING ELECTRICAL INSTALLATION TRAINING PROGRAM  
AT THE BANDA ACEH WORK TRAINING CENTER (BLK)**

TABLE 1 ALTERNATIVE ANSWER SCORE

No	Category	Value
1	Strongly Agree	4
2	Agree	3
3	Disagree	2
4	Strongly Disagree	1

- c. Add up the scores obtained from each respondent
- d. The results obtained are consulted with the category table.

As for seeing the percentage score of the assessment can be seen in Table.

TABLE 2 PERCENTAGE OF VALUE

No	Score	Interpretation
1	$0\% \leq x \leq 25\%$	Strongly Disagree
2	$26\% < x \leq 50\%$	Disagree
3	$51\% < x \leq 75\%$	Agree
4	$75\% < x \leq 100\%$	Strongly Agree

#### 4. Result and Discussion

##### a. Reaction Aspect

The reaction aspect is the first evaluation level in Kirkpatrick's evaluation model. On In this aspect, an evaluation is carried out to measure participants' knowledge of the material, interests, motivation and attention level of the participants. There are several indicators in the reaction aspect, namely; programs, materials, instructor competencies, facilities and effectiveness.

TABLE 3 ASPECT OF REACTION

No	Indicator	Score	Category
1	Appropriate Training Program according to the needs of the participants	88.75%	Very Good
2	Relevant training materials participant needs	78.88%	Very Good
3	Competence of training instructors/facilitators	86.88%	Very Good
4	Smooth support facilities training	86.25%	Very Good
5	Effective use of time	80.83%	Very Good

Based on the graph above, the results of the evaluation of the BLK are based on indicators, namely: (a) Program, namely training programs in accordance with the needs of participants get a score of 88.75, (b) Training material, namely training material relevant



**THE EVALUATION OF BUILDING ELECTRICAL INSTALLATION TRAINING PROGRAM  
AT THE BANDA ACEH WORK TRAINING CENTER (BLK)**

to the needs of participants, gets an average score 78,88, (c) On the competency indicators for instructors or training facilitators have an average score 86.66, (d) Facilities, namely facilities supporting the smooth running of training have an average score 86.25 and (e) on effectiveness, namely the effectiveness of the use of time has an average score of 80.83 From the results of the reaction it can be concluded that during the process at the Reaction level stage the response from the training participants was very good and went well.

**b. Learning Aspect**

In general, the training organized by BLK Banda Aceh aims to: equip training participants with skills, especially about electrical installation of buildings simple. In this training program, participants are expected to be able to have the skills and Knowledge of simple building electrical installations. In the process of skills training (level learning) participants do not only get theory only, but also carry out processing practice activities. In this second aspect, there are two indicators namely competence and participation in learning. In the learning process, the instructor stimulate the creativity and activeness of the trainees through classroom learning and practice. Matter this makes the trainees feel more energized and enthusiastic to learn about simple electrical installation.

TABLE 4 ASPECT OF LEARNING

No	Indicator	Score	Category
1	Participant competency	83.57%	Very Good
2	Participation (attendance and participant activity during training)	80.83%	Very Good

Based on the picture above it is known that for each learning indicator, there are indicators seen in the Learning stage of the building electrical installation training program simple there are two indicators first indicators of participant competency and participant participation and the results of the answers of the training participants obtained the average results for each indicator, namely: (a) on participant competency indicators, namely (knowledge, attitudes and skills of participants before and after getting an average result of 83.57 from the answers of the participants in the electricity installation training simple buildings and (b) on indicators of participant participation, namely attendance and activity participants during the training obtained an average score of 80.83. Based on the explanation above, it can be concluded that the response of the training participants at the Learning stage of a very simple building electrical installation training program well, in the learning process a lot of new knowledge was gained by the participants about electrical installation material delivered by the instructor.

**c. Behavior Aspect**

From the results of the behavior, there was a change in the behavior of the participants during the training. There is a change in self-motivation at work, responsibility at work, independence and teamwork. This change in behavior occurs from the learning process at the time training. It is expected that during the training program, participants are able to form habits or positive attitudes to the world of work. In addition, participants become more skilled than previously.

**THE EVALUATION OF BUILDING ELECTRICAL INSTALLATION TRAINING PROGRAM  
AT THE BANDA ACEH WORK TRAINING CENTER (BLK)**

TABLE 5 ASPECT OF BEHAVIOR

No	Indicator	Score	Category
1	Personality transformation trained	83.33%	Very Good
2	Social competence (team work)	0%	Very Poor
3	Interpersonal communication	86.66%	Very Good

Based on the data the results of evaluating aspects of behavior are obtained based on each indicators, namely: (a) Changes in personality that were trained to get an average result of 83.33, (b) Social competence (teamwork) gets an average result of 0 and (c) Interpersonal communication get an average yield of 86.66. On social competence got a score of 0 because this training focuses on individuals, where this training is not carried out in teamwork, then in the category of teamwork get a score of 0. From the explanation above it can be concluded that the response of the training participants at the level Behavior is in the good category, participants show behavior that tends to be positive, as long as training participants attended each training properly and responsibly.

**d. Result Aspect**

The simple building electrical installation training was very beneficial for all participants training. Participants who initially did not have skills regarding electrical installation simple building, be skilled. Even with a background of regional origin different, educational backgrounds are not the same, even organizations that work or not, participants continue to follow the training process and feel the benefits obtained during the training training program.

TABLE 6 ASPECT OF RESULT

No	Indicator	Score	Category
1	Quantity Increase and Quality	81.25%	Very Good

Based on the picture above it is known that the aspect of results (results) is based on indicators evaluation, namely increasing the quantity and quality of work which is the result of the training program with an average result of 81.25. This shows that the results of the training can be felt directly by the trainees. Based on the explanation above, it can be concluded that at the Result level, the response from the participants were very good, from these results it can be seen that after the training the participants got lots of additional knowledge that is very useful for dealing with the world of work.

**References**

- [1] Arikunto.Dasar-dasar Evaluasi Pendidikan, Jakarta: Bumi Aksara, 2009.
- [2] Budi Santoso.Skema dan Mekanisme Pelatihan, Jakarta: Terangi, 2010.
- [3] Nurdin Mohayat,' Modul Pembelajaran Matematika Berbasis Pisa',2018.
- [4] Pemerintah Aceh. Qanun Aceh Nomor 8, Pasal 1 Ayat 42 Tentang Penyelenggaraan Ketenagakerjaan. 2003

## AN ANALYSIS OF TEAMVIEWER AND ULTRAVNC PERFORMANCE ON WIFI NETWORKS

Aulia Syarif Aziz<sup>1</sup>, Syakirun Mukmin<sup>2</sup>, Ridwan<sup>3</sup>, dan Firmansyah<sup>4</sup>

<sup>1234</sup>Program Studi Pendidikan Teknologi Informasi, UIN Ar-Raniry  
E-mail: aulia.aziz@ar-raniry.ac.id

### Abstract

One of the challenges that educators faced in online learning during the Covid-19 was the implementation of practicums. Educators have difficulty supervising and controlling student activity during the practicums process. Not to mention that many students are distracted and doing other activities that can interfere with the practicum, such as browsing social media and watching streaming videos. In order to solve this, teachers and educators can utilize application such as a remote desktop to monitor and control student activity. In this study, we compared the performance of remote desktop applications TeamViewer and UltraVNC based on throughput, packet loss, delay, and jitter parameters. Measurements were carried out using a wireshark with a school computer laboratory wifi network. The measurement results show that UltraVNC produces higher throughput and packet loss than TeamViewer. However, TeamViewer has higher delay and jitter than UltraVNC.

**Keywords:** *TeamViewer, UltraVNC, throughput, packet loss, delay, jitter.*

### 1. Introduction

The Covid-19 pandemic has had many impacts on the way of human life, one of which is the teaching and learning process in the school environment. Learning that was previously carried out traditionally in classrooms has been transformed into online learning via the internet. To support the online learning process, sufficient facilities are needed, such as computers and a proper network connection.

One of the challenges faced in online learning is the implementation of practicum. In carrying out online practicums, teachers find it difficult to monitor student work. In addition, students also often distracted by other activities that are not related to learning, for example accessing social media, watching video streaming, and others [1]. Therefore, an application is needed that can be used to monitor and control students in carrying out practicums, for example, such as TeamViewer and UltraVNC. TeamViewer and UltraVNC is a remote desktop application that can help teachers to monitor and assist students during practicums.

TeamViewer and UltraVNC both work as remote desktops, but each has its own advantages and disadvantages. Therefore, researchers are interested in examining the performance of TeamViewer and UltraVNC in school laboratory networks based on throughput, packet loss, delay, and jitter parameters. The results of this study are expected to be useful for researchers and specially educators in choosing suitable remote desktop applications for monitoring and controlling student activity.

## 2. Literature Review

### Internet

The internet network is a connection between one computer and other computers around the world. So, the internet can also be interpreted as a global network built from computers that are interconnected and work together to share information and data using the TCP IP protocol. That way it can be said that the Internet is a combination of various types of existing networks, so that one computer with another can communicate with each other. Network models include LAN, MAN, WAN, and Intranet [2]. Generally, to access the Internet, users use a wireless LAN (WLAN) which is connected to an internet service provider (ISP) [3].

### Quality of Service

Quality of Service is a mechanism or management technique by doing measurement of parameters such as throughput, delay, and packet loss of data traffic on a network. The purpose of using the QoS mechanism is to find out one or more of the four basic QoS parameters previously mentioned in order to increase the productivity of end users (clients) by ensuring the users to receive good network performance. QoS focuses on the ability of a network to provide better service than a particular network flow through various data transmission technologies [4].

As mentioned earlier, several QoS parameters are throughput, jitter, delay, and packet loss. Throughput is the actual bandwidth that is measured in a certain period of time when transmitting data. It's different than bandwidth even though it has the same units of bits per second (bps) [5]. Jitter can be caused by various aspects, such as data queue length, data processing time, and also the time to reassembly received package at the end of the transmission [6]. Delay is the time required for data for a packet to be sent from one computer to the destination computer. Delay in a packet transmission process in a computer network is caused by long queues or taking other routes to avoid congestion on routing [8]. Packet loss is the percentage of packets lost when transmitting data, for example due to the network transmission media, errors in network hardware, and radiation from the surrounding area.

### Remote Desktop

Remote desktop is a technology that allows the users to be able to access and control another computer over connected network. The users of remote desktops have the ability to see the remote computer displays over a network, also control the remote computer using keyboard and mouse from the user computer itself [7].

### TeamViewer

TeamViewer is a software that is generally used for remote desktop purposes, both for personal and commercial use. This study utilizes the portable version of TeamViewer. By connecting two computers with TeamViewer, it will show the display of the remote computer. TeamViewer allows one to transfer files, chat, and make video calls between computers connected through the network [8].

### UltraVNC

UltraVNC is a free and open-source remote desktop software that is simple and easy to operate. UltraVNC can remote other computers and it has access to control the remote computer using mouse and keyboard through the user computer. The users feel like they are directly in front of the remote computer. UltraVNC is an open-source application, this application uses the Microsoft Windows operating system so that it can run the VNC protocol when controlling other computers remotely [9].

**Wireshark**

Wireshark is software for analyzing computer network activity. Wireshark has useful functions for professional users, network administrators, researchers, and network software developers. Wireshark works in real time in capturing packets of data/information running through the network. All types of information packets in various protocol formats will be easily captured and analyzed [10].

**3. Method**

This study uses an experimental method by comparing the performance of TeamViewer and UltraVNC on 6 computers. 1 computer is used as a remote desktop client as well as a host to measure the QoS, 1 other computer used as a remote desktop server and to stream YouTube videos, and 4 other computers as remote desktop servers only.

QoS measurements were carried out using Wireshark with the parameters measured namely throughput, jitter, packet loss, and delay. Data collection was carried out seven times, respectively at the first minute, fifth minute, tenth minute, fifteenth minute, twentieth minute, twenty-fifth minute, and thirtieth minute.

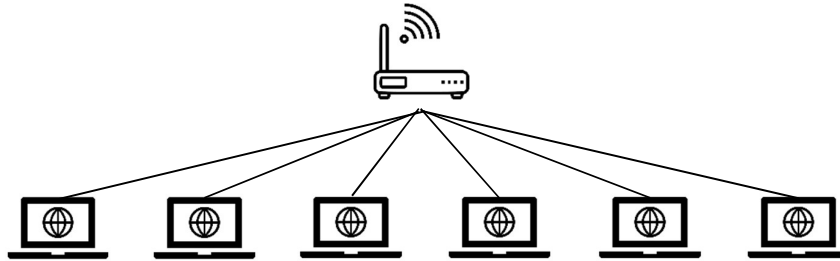

Figure 1. Network topology used in this experiment

**4. Results and Discussions**

From the data collection that was carried out seven times on TeamViewer, an average throughput value of 936 Kpbs was obtained, packet loss was 0.274%, delay was 5.87 ms, and jitter was 5.87 ms. While UltraVNC has an average throughput of 3279 Kbps, 0.007% packet loss, 1.72 ms delay, and 1.72 ms jitter. The complete data can be seen in table 1.

Table 1. Throughput, packet loss, delay, and jitter in TeamViewer and UltraVNC

Time	TeamViewer				Ultra VNC			
	Throughput (Kbps)	Packet loss (%)	Delay (ms)	Jitter (ms)	Throughput (Kbps)	Packet loss (%)	Delay (ms)	Jitter (ms)
1 minutes	588	0,070	4,51	4,51	5858	0,007	1,72	1,72
5 minutes	385	0,129	11,03	11,03	3	0,003	2,43	2,43
10 minutes	1168	0,563	4,51	4,51	4608	0,000	1,72	1,72
15 minutes	1038	0,583	5,22	5,22	3432	0,006	2,36	2,36
20 minutes	1306	0,564	4,51	4,51	3185	0,002	2,25	2,25
25 minutes	1401	0,000	3,95	3,95	2099	0,000	3,06	3,06
30 minutes	670	0,005	7,42	7,42	3768	0,071	2,16	2,15
Average	936	0,274	5,87	5,87	3279	0,013	2,24	1,90

Comparison of throughput values between TeamViewer and UltraVNC looks quite significant. TeamViewer throughput values range from 385 Kbps to 1401 Kbps. Meanwhile, UltraVNC throughput values range from 3 Kbps to 5858 Kbps.

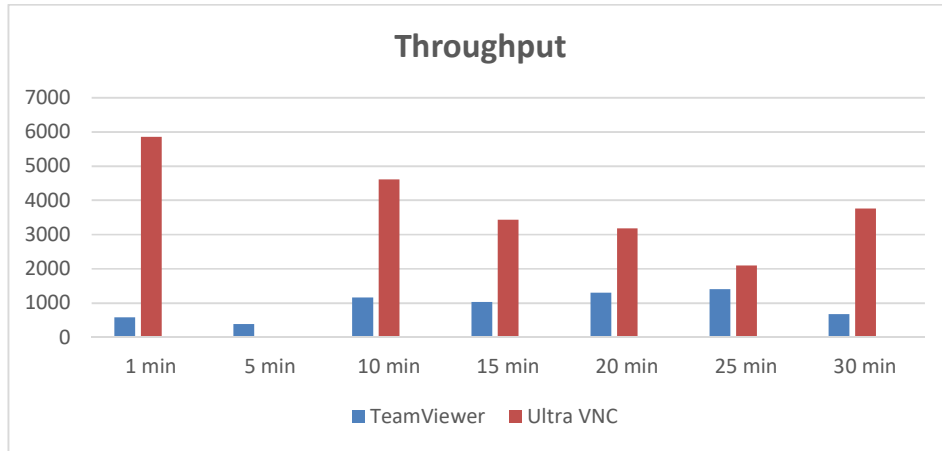

Figure 2. Throughput Chart of TeamViewer and UltraVNC

The smallest packet loss value on TeamViewer is 0.000% and the largest is 0.583%. Whereas on UltraVNC, the smallest packet loss is 0.000% and the largest is 0.071%.

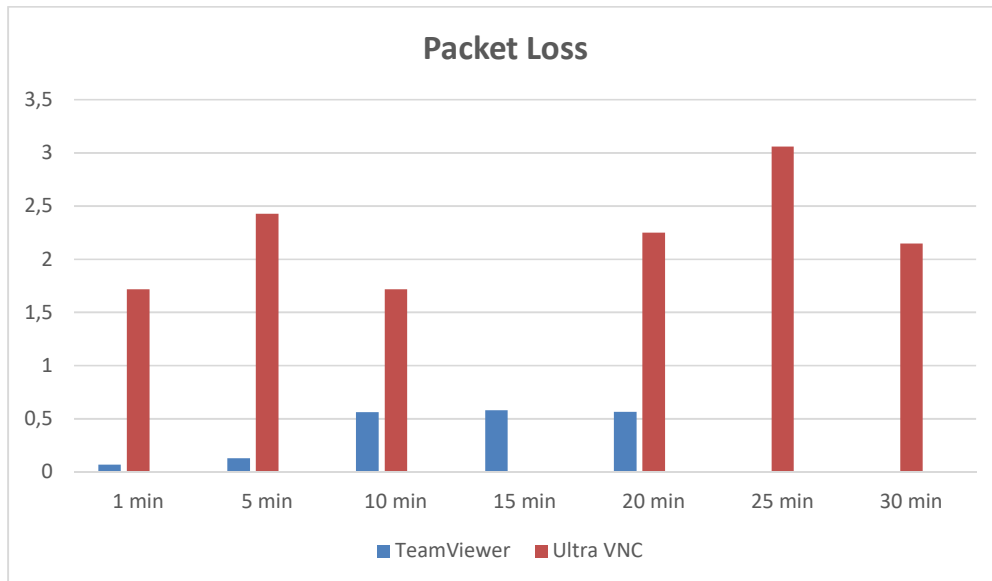

Figure 3. Packet loss chart of TeamViewer and UltraVNC

TeamViewer's delay ranges from 3.95 ms to 11.03 ms. Meanwhile, the delay on UltraVNC ranges from 1.72 ms to 3.06 ms.

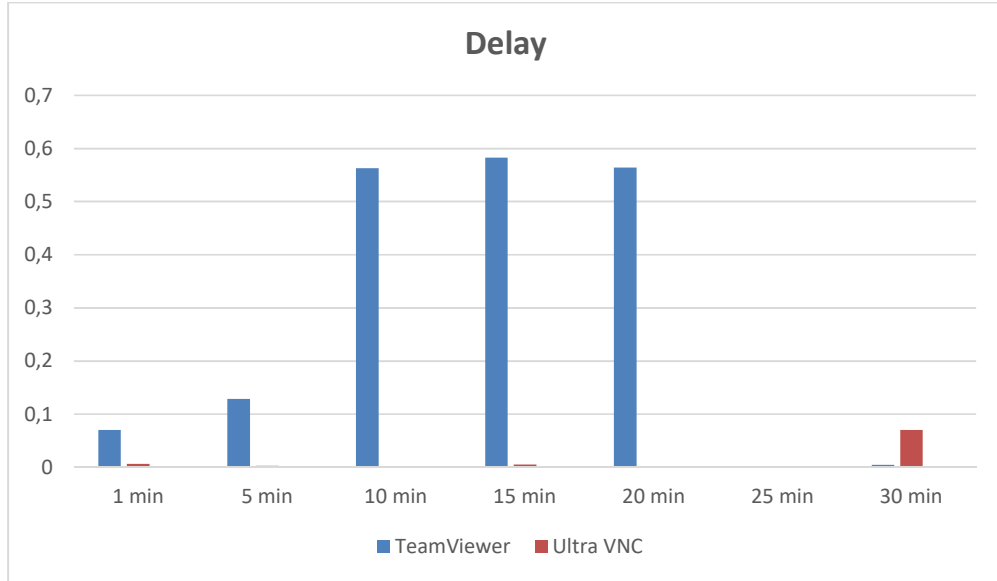

Figure 4. Delay of TeamViewer and UltraVNC

Meanwhile for jitter, in TeamViewer the value ranges from 3.95 ms to 11.03 ms. And the jitter on UltraVNC ranges from 1.72 ms to 3.06 ms.

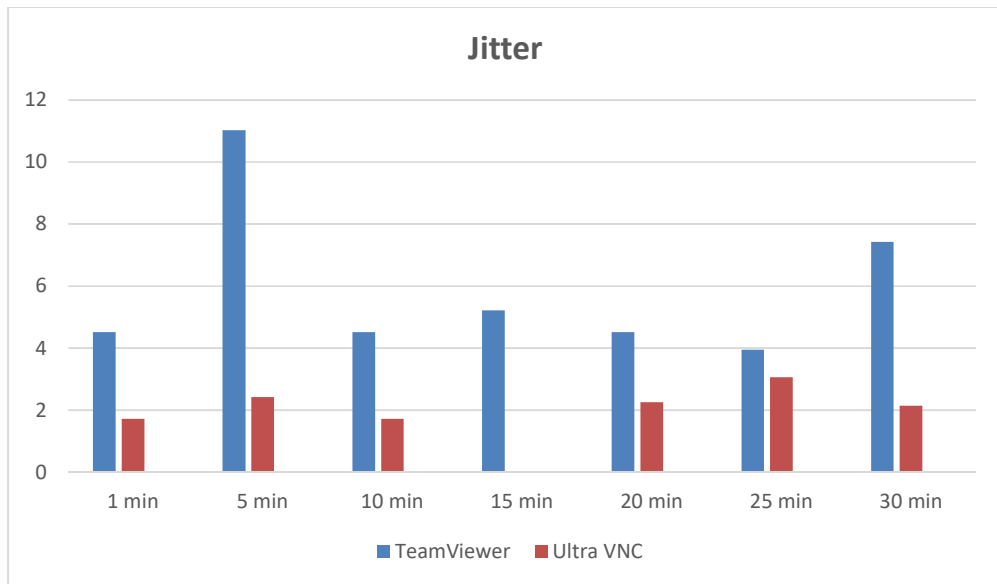

Figure 5. Jitter of TeamViewer and UltraVNC

Based on the tests that have been carried out, it can be concluded that UltraVNC produces higher throughput and packet loss than TeamViewer. However, TeamViewer has higher delay and jitter than UltraVNC. It can be concluded that UltraVNC produces a higher display quality by utilizing more network throughput. Besides, each of them also has different feature. Both applications can be used according to users' needs.



## References

- [1] N. W.-J. P. A. (JPAK) and undefined 2015, "Pengaruh Computer Knowlegde, Computer Attitude, Dan Fasilitas Laboratorium Komputer Terhadap Hasil Belajar Komputer Akuntansi Siswa Kelas XI Akuntansi," *ejournal.unesa.ac.id*, Accessed: Dec. 09, 2022. [Online]. Available: <https://ejournal.unesa.ac.id/index.php/jpak/article/view/32744>
- [2] Ikhsan, "Pengendalian Kontrol PC Jarak Jauh dengan Memanfaatkan Media Internet Berbasis Client Server," *Teknoif*, vol. 2, no. 1, 2014, Accessed: May 22, 2022. [Online]. Available: <https://teknoif.itp.ac.id/index.php/teknoif/article/view/323>
- [3] F. Firmansyah, I. Bajili, H. Ahmadian, and A. S. Aziz, "Implementasi Dan Analisis kinerja Antena Wajan Bolic Sebagai penerima Sinyal Wi-Fi," *Cyberspace: Jurnal Pendidikan Teknologi Informasi*, vol. 6, no. 2, p. 96, Oct. 2022.
- [4] Aprianto Budiman, M. Ficky Duskarnaen, and Hamidillah Ajie, "ANALISIS QUALITY OF SERVICE (QOS) PADA JARINGAN INTERNET SMK NEGERI 7 JAKARTA," *PINTER J. Pendidik. Tek. Inform. dan Komput.*, vol. 4, no. 2, pp. 32–36, 2020, doi: 10.21009/pinter.4.2.6.
- [5] P. R. Utami, "ANALISIS PERBANDINGAN QUALITY OF SERVICE JARINGAN INTERNET BERBASIS WIRELESS PADA LAYANAN INTERNET SERVICE PROVIDER (ISP) INDIHOME DAN FIRST MEDIA," *J. Ilm. Teknol. dan Rekayasa*, vol. 25, no. 2, pp. 125–137, 2020, doi: 10.35760/tr.2020.v25i2.2723
- [6] A. R. Hakim, N. Tjahjamoonsih, and D. Suryadi, "Analisis Kualitas Jaringan Internet Dengan Sinyal 4G LTE Dengan Metode QOS," *J. Tek. Elektro Univ. Tanjungpura*, vol. 2, no. 1, pp. 1–9, 2021, Accessed: Jun. 25, 2022. [Online]. Available: <https://jurnal.untan.ac.id/index.php/jteuntan/article/view/48187>
- [7] E. Penggunaan *et al.*, "Efektivitas penggunaan aplikasi remote control teamviewer sebagai monitoring praktek di laboratorium komputer kelas xi smk negeri 1 wera," *academia.edu*, 2019, Accessed: May 22, 2022. [Online]. Available: [https://www.academia.edu/download/60222445/SKRIPSI\\_ANDI\\_PTI\\_201920190806-66314-80qmxm.pdf](https://www.academia.edu/download/60222445/SKRIPSI_ANDI_PTI_201920190806-66314-80qmxm.pdf)
- [8] S. Saeed and M. Alam, "PERFORMANCE ANALYSIS OF SECURE & EFFICIENT REMOTE DESKTOP MANAGER," *jict.ilmauniversity.edu.pk*, Accessed: Dec. 27, 2022. [Online]. Available: <http://jict.ilmauniversity.edu.pk/journal/jict/11.1/4.pdf>
- [9] K. Saleh, "RANCANGAN PERANGKAT LUNAK PENGENDALI ROBOT PEMANTAU BERBASIS PONSEL PINTAR ANDROID," *Saintek ITM*, vol. 32, no. 2, 2019, doi: 10.37369/si.v32i2.56.
- [10] R. Hanipah and H. Dhika, "Analisa Pencegahan Aktivitas Ilegal Didalam Jaringan Dengan Wireshark," *DoubleClick J. Comput. Inf. Technol.*, vol. 4, no. 1, p. 11, 2020, doi: 10.25273/doubleclick.v4i1.5668.

## CONTROL AND MONITORING SYSTEM DESIGN OF INTERNET-BASED ELECTRICAL INSTALLATIONS

**Abdul Hanif<sup>1</sup>, Hari Anna Lastya<sup>2</sup>, Muhammad Ikhsan<sup>3</sup>**

<sup>1,2,3</sup>Electrical Engineering Education Study Program, Faculty of Tarbiyah and Teacher  
Training Ar-Raniry State Islamic University Banda Aceh

### **Abstract**

Technological developments encourage humans to be able to adapt to their developments so humans must open their horizons in thinking creatively and innovatively to maximize the performance of a job or security that can be developed to continue to produce the latest works. Technology can be used as a system or tool that can facilitate all daily human activities where it can be used manually or can be used automatically using technology. In this research, technology is used to alleviate human worries about using electricity at home, where researchers create a design system for controlling and monitoring electrical installations based on the Internet of Things that can control and monitor the use of electric power through the Blynk application using experimental research types to see success or failure. not used as a monitoring system and control system. The results obtained in this study are that the work system using electric power can be controlled manually and automatically via the internet using the Blynk application to turn on and turn off electricity with a response duration of 0.5 – 1 second. This tool is also used as a monitoring tool in the use of electric power at each load using the Blynk application with manual measurement comparisons with a value of 0.95 – 2.00% which is used according to load usage.

**Keywords:** IoT, Control, Monitoring, NodeMCU ESP8266, Blynk.

### **1. Introduction**

In the current era of globalization 4.0, information technology is developing rapidly and increasingly advanced, so it becomes an encouragement for humans to continue to innovate, think creatively, and not only create discoveries, but also optimize the performance of systems and technologies that have been created before in meeting maximum human work system [1]. Thus, this technology is also known as the Internet of Things (IoT). The Internet of Things is a future where all devices are connected to the internet to form a system that has its own intelligence and is very useful in technological developments, such as the application of smart homes. This can be achieved by using data analysis, and information representation with cloud storage as a data repository.

The Internet of Things has three characteristics, namely objects or materials assigned to measuring devices/devices, lines that are interconnected through network terminals, and intelligent services. Electronic devices used in a home installation can be controlled or controlled for their use through computer and Android applications. Computer applications are currently also used on gadget devices such as smartphones. The use of smartphone devices in the country has reached 61.7% of the total population [2]. Smartphones have completely developed or evolved in human life, work, and time with the tremendous growth of resources and services. Smartphones that are portable,

personal, and easily connected to other devices can be used as an application of the Internet of Things. This proves that people are used to using mobile devices.

The use of Internet of Things can be utilized for various kinds of needs in everyday life to facilitate human work so that various design ideas arise that can be used in various ways. One of the Internet of Things tool designs that researchers have made is a system for controlling and monitoring electricity usage in households. Consumer negligence in using electricity at home is generally found when leaving the house, such as forgetting to turn off electrical devices such as electronic devices that consume electricity and can cause a house fire. Therefore, users often feel uncomfortable when traveling long distances or so on.

To overcome the concerns of home electricity users, researchers want to project an exchange switch into a series of electrical installations in the form of lighting installations and the use of electronic equipment that can be controlled manually and can also be controlled via internet media using the Cloud Network which has been programmed previously on NodeMCU ESP8266 using the Arduino IDE software using a Personal Computer (PC) or Smartphone. The advantages of the tools used by researchers to design control systems and monitor electrical installations are; first, the designed electrical installation design is designed to obtain more secure electricity use through application monitoring without the need for further supervision from any party. The safety example in question is such damage to the load which causes excess current or leakage so that the user can take follow-up by cutting off the electric current in the load through the Blynk application. Second, home users don't have to go back and forth to the house to check electricity usage on home appliances that have forgotten to turn off or turn on. Third, each of these electrical appliances has been installed in the form of a smart control media, users are calmer because all electrical equipment at home can be controlled anywhere using a smartphone/gadget.

The objectives of this research are: The application of a control system can minimize concerns about the use of electricity at home from negligence. As well as a user monitoring system that can control unwanted electricity usage remotely.

## **2. Theoretical Studies**

### **2.1. Control System Design**

The design of the control system used in this study is in the form of a feedback control system (closed control system), the working system of the research tool is a control device that can be controlled through network media using an application or web server using Google Assistant as a tool.

Relay is a device that is controlled by current. The relay has a low-voltage coil applied to a core component. There is an iron shield that will be attracted toward the core when current flows through the coil. This iron guard is attached to a spring lever. When the shield is pulled toward the core, the common line contact will change its position from a Normally Close (NC) contact to a Normally Open (NO) contact.

The use of relays in electronic circuits is as an executor as well as a liaison/interface between loads and electronic control systems that have different power supply systems. Physically the contactor or switch with a separate electric magnetic between the load and the control system is separate. The main part of the electro-mechanical relay is the switch electromagnet coil or the Swing Armature Spring contactor [3]. Relays are also called electronic switches, that is, switches can be controlled with other electronic devices such as Arduino.

## 2.2. Electrical Installation Monitoring

Electrical Monitoring is the monitoring of electric power which is mostly done by combining several electrical measuring devices in the form of sensors before connecting to the load used. The advantage of this monitoring is that electric power consumption can be monitored in real-time from anywhere through the application [4]. The hardware used for monitoring electricity use is Pzem 004 –T.

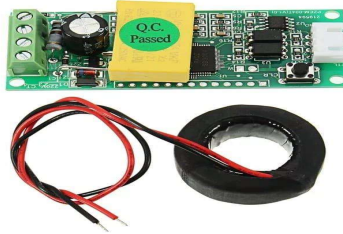

Figure 1. PZEM 004-T Sensor Shape

PZEM 004-T is an electric power sensor that is multifunctional in monitoring and can calculate the accuracy of power usages such as voltage, current, active power, and power consumption. This module has its own Time To Live (TTL) pin which is a pin that supports serial data communication with other hardware using a computer's USB or RS-232 port [5].

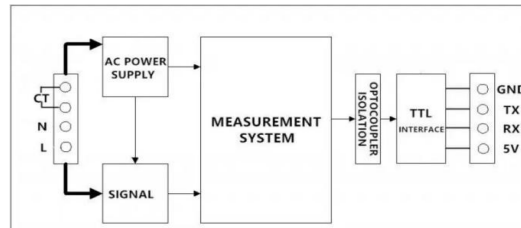

Figure 2. Form of sensor functional block diagram

Based on the sensor functional block diagram in the Pzem 004-T working system image, the application can be seen in the Open System Interconnection (OSI) section of the application layer on the Pzem 004-T sensor using the Modbus protocol system - Remote Terminal Unit (RTU) in communication or serial.

## 2.3. Internet of Things

Internet of Things technology can be applied to create a new concept and development related to smart homes to provide convenience. This aims to help improve security and provide convenience for someone who uses the device by utilizing the network. The hardware used in the Internet of Things is NodeMCU ESP8266 as shown in Figure 3.



Figure 3. NodemMCU ESP8266 Shape Image

NodeMCU is an electronic board based on the ESP8266 chip with the ability to perform microcontroller functions and also an internet connection. NodeMCU has several Input / Output pins so that it can be developed into a monitoring/monitoring application as well as a control tool for IoT projections. NodeMCU ESP8266 can be programmed with the Arduino programming language using the Arduino IDE application. The physical form of the NodeMCU ESP8266 has a Universal Serial Bus (USB) port so that users can easily program it [6].

NodeMCU ESP8266 is a development module derivative of the Internet of Things device module ESP8266 family type ESP-12. The function of this module is almost similar to the Arduino module device, but what distinguishes it is that it is specifically used for "Connected to Internet" internet connections.

#### 2.4. Electrical Installation System

The basic need for electricity has a very important role in everyday life, almost all buildings such as housing, offices, and so on require electrical energy. Electrical installation is a method or process of channeling electrical energy from an electric power source to a load that is adjusted to the provisions stipulated in existing electricity regulations and standards [7]. There are two parts to the electrical installation: first, the electric lighting installation is an installation that is used to provide electrical power to lamps. Both electric power installations are installations that are used for distribution in the form of electric current through a socket so that it can be used to turn on electrical devices such as washing machines, televisions, and others [8].

The most important electrical circuits needed in a circuit are the components used in various ways in electrical installations. Electrical installation components themselves can be grouped into several sections, including Switches, Sockets, and Lights.

### 3. Research Methodology

In designing this tool, researchers used experimental research types. Conducting experiments on the design of control and monitoring systems is a process of testing the previous theories to prove their truth. The experimental objective to be achieved from this research is to design an electrical installation for power and lighting Internet of Things control, with this tool home users no longer need to worry about negligence in using lights or electronic equipment which can be turned off using a smartphone remotely using internet media, NodeMCU ESP8266 serves as the central microcontroller that controls all the performance of this automatic controller.

The research model used in the design of this control and monitoring system is the ADDIE model (Analysis, Design, Development, Implementation, and Evaluation) [9]. This model is widely used and applied in conducting research related to the

## CONTROL AND MONITORING SYSTEM DESIGN OF INTERNET-BASED ELECTRICAL INSTALLATIONS

assessment of a tool or the development of a tool.

At this research stage, researchers want to use a tool that everyone can use so that with this tool the use of the electric current in the house can be controlled and home security can also be monitored remotely using a smartphone.

The stages used in this study started from the planning stage of the model to the final results of the study. In this research design stage, the researcher made a focus point related to the type of research model. The explanation of the stages used in the research flow includes Literature Study, Planning Stage, Tool Design Stage, Tool Programming Stage, Tool Testing, Tool Implementation, and Test Results.

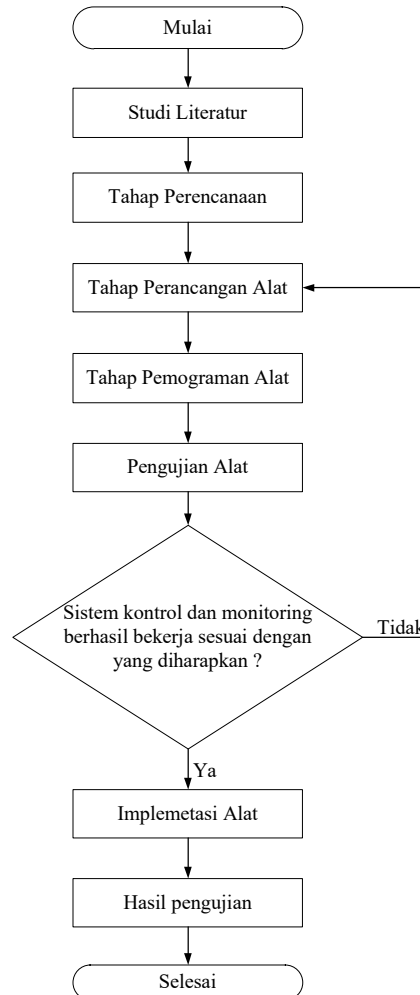

Figure 4. Form of Research Flow

#### 4. Research Results and Discussion

In installing the electrical installation of this control and monitoring system device, does not require its electrical installation, the installation that is applied to this tool is only changing the basic electrical installation in the Figure below.

# CONTROL AND MONITORING SYSTEM DESIGN OF INTERNET-BASED ELECTRICAL INSTALLATIONS

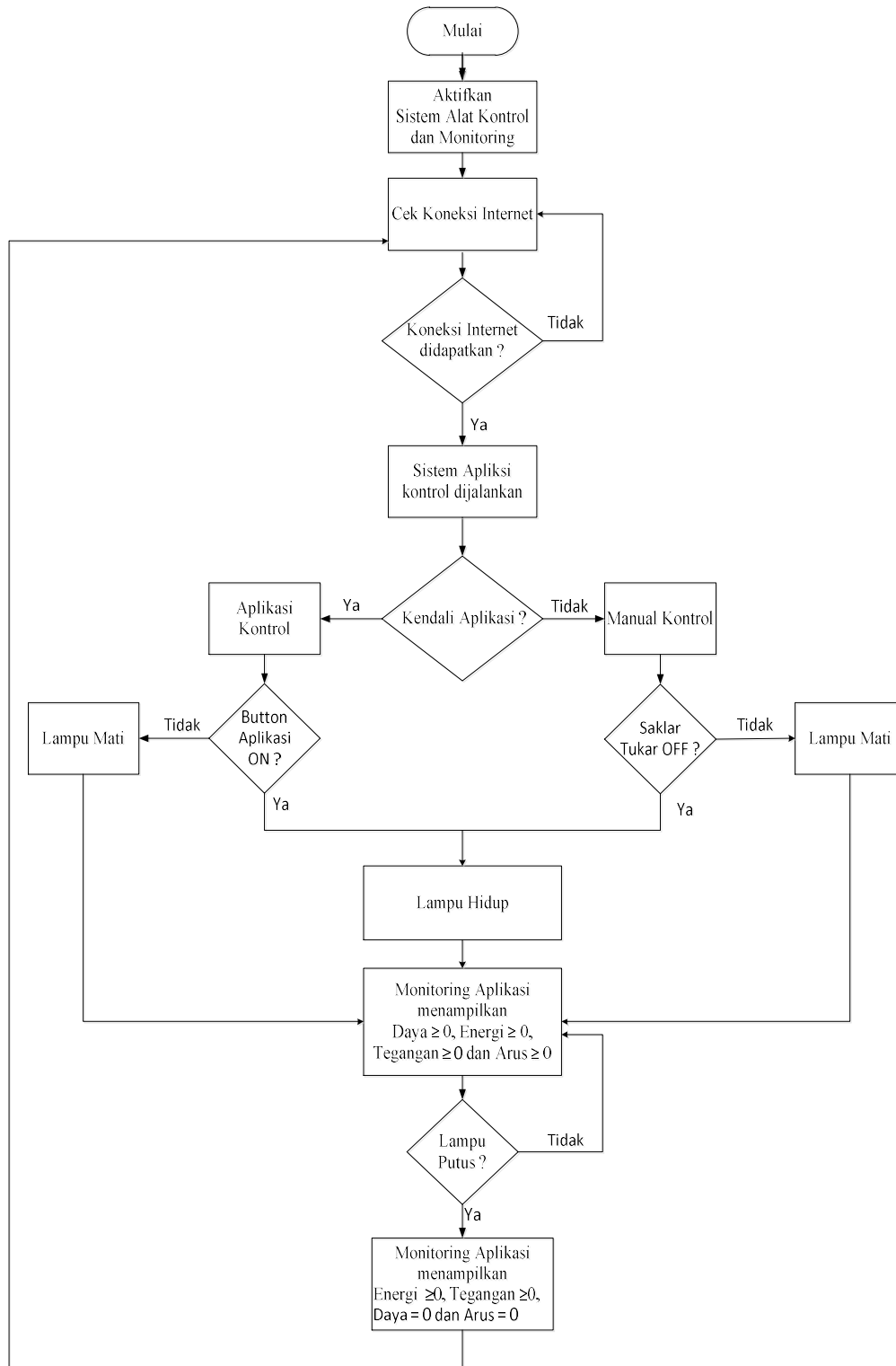

Figure 5. Flowchart of IoT-based and manual electricity control and monitoring work systems

## CONTROL AND MONITORING SYSTEM DESIGN OF INTERNET-BASED ELECTRICAL INSTALLATIONS

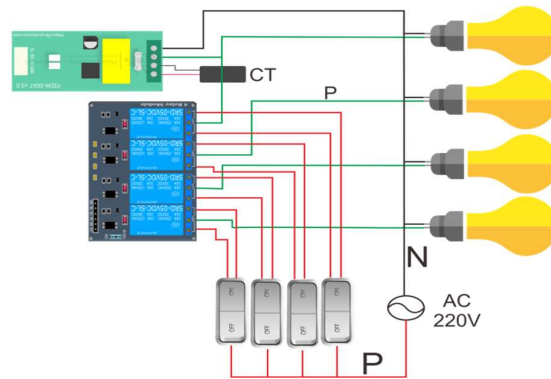

Figure 6. Basic electrical installation circuit

The process of the working system of the control and monitoring tool is turned on for the first time, then the tool will continue to search for the internet network that has been programmed in the circuit so that it will continue at the next stage the user can choose which control system he wants. Users can control using the Blynk application the use of electricity on one or more loads and users can turn off the electricity flowing at these loads using a swap switch manually without having to turn off the control application on the Blynk screen. Follow-up of the use of this control system will display power, voltage, and current energy on the monitoring display of the Blynk application. So that the user can find out how much power and energy usage is spent on the load the user can limit himself in the use of power on the load. The monitoring display will always display each load used so that if an error occurs in the load such as a broken lamp, the next step that must be taken is to turn the light on and off first so that the user can make sure the lamp is broken or is being turned off.

### 4.1. Results of Electrical Circuit Installation Control System Design

The results of this electrical installation control system design work with the programming logic that was made previously using the C programming language through the Arduino IDE application, the programming logic embedded in this tool has 2 conditions (working system state), in the first condition the researcher makes a control input system design relay to each load switch that is used to disconnect or connect electrical power. In the second condition, the control system can be carried out directly without the need for a control application to disconnect and connect the electric power to the load, but the monitoring system will automatically display the use of the electric power being used by the load.

The results of the control system testing using the Blynk application carried out on the network aim to see the response time to the working system turning on and off on lamp 1 having an average value of 1.2 seconds. The results of the work system response test carried out on lamp 1 can be seen in Table 1.



**CONTROL AND MONITORING SYSTEM DESIGN OF INTERNET-BASED ELECTRICAL INSTALLATIONS**

Table 1. Test the response of the work system to lamp 1

No	Testing With Blynk On Lights 1	
	Blynk Application ON / OFF Testing	Response Time
1	Testing 1	1 second
2	Testing 2	2 second
3	Testing 3	0.5 second
4	Testing 4	2 second
5	Testing 5	0.5 second
6	Testing 6	0.5 second
7	Testing 7	0.5 second
8	Testing 8	1 second
9	Testing 9	2 second
10	Testing 10	2 second
Rate - Rate		1.2 s second

The results of testing the control system using the Blynk application which is carried out on the network on the working system of turning on and off lights 2 aim to see the response time has an average value of 1.2 seconds. The results of the work system response test carried out on lamp 2 can be seen in Table 2.

Table 2 Test the response of the working system on lamp 2

No	Testing with Blynk on lamp 2	
	Testing ON / OFF the Blynk application	Response time
1	Testing 1	2 second
2	Testing 2	2 second
3	Testing 3	1.5 second
4	Testing 4	2 second
5	Testing 5	1 second
6	Testing 6	0.5 second
7	Testing 7	0.5 second
8	Testing 8	1.5 second
9	Testing 9	0.5 second
10	Testing 10	1 second
Rate - rate		1.25 second

The results of subsequent testing of the working system of turning on and off lamp 3 aim to see the response time have an average value of 1.25 seconds. The results of the work system response test carried out on lamp 3 can be seen in Table 3.

## CONTROL AND MONITORING SYSTEM DESIGN OF INTERNET-BASED ELECTRICAL INSTALLATIONS

Table 3. Testing the response of the work system to lamp 3

No	Testing with Blynk on lamp 3	
	Testing ON / OFF the Blynk application	Response time
1	Testing 1	0.5 second
2	Testing 2	1.5 seconds
3	Testing 3	0.5 second
4	Testing 4	2 second
5	Testing 5	0.5 second
6	Testing 6	0.5 s second
7	Testing 7	0.5 second
8	Testing 8	1 second
9	Testing 9	0.5 second
10	Testing 10	1.5 seconds
Rate - rate		0.9 second

After the tests were carried out on each load 10 times repeatedly, it can be concluded that the response speed of the work system on this control device greatly affects the network connection, the better the network speed used, the better the work system will be in responding to commands given.

### 4.2. Results of Electrical Installation Monitoring

The steps in designing an Internet of Things-based electrical installation control and monitoring system are as follows:

- a. Prepare the tools and materials to be used
- b. Connect all the modules and components as shown in Figure 7 of the network module.
  - 1) NodeMCU ESP8266

NodeMCU ESP8266 is a module used in designing an Internet of Things-based electrical installation control and monitoring system that functions as a central controller tasked with giving orders and the brain of the system in controlling all commands given by the user.

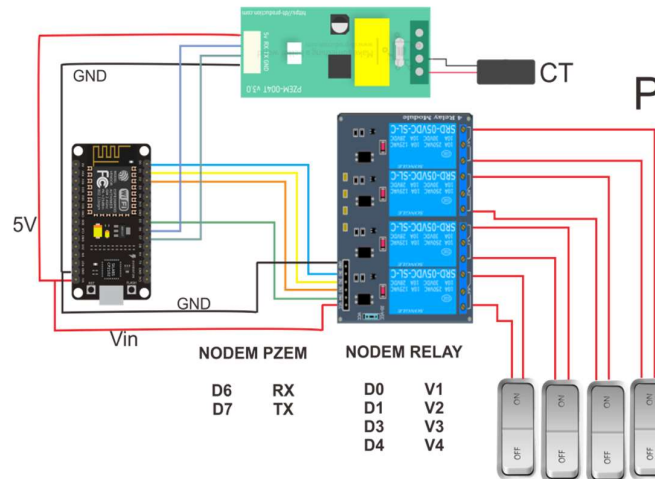

Figure 7. NodeMCU installation circuit with relays and sensors

## CONTROL AND MONITORING SYSTEM DESIGN OF INTERNET-BASED ELECTRICAL INSTALLATIONS

### 2) Sensor Pzem 004-T

The Pzem 004-T sensor has 4 output pins that function as detection pins for the use of current, voltage, active power, and AC power energy which can be used to measure 0 – 100A current, 80 – 260V voltage, in the use of these output pins usually 2 pins are used. The first is to connect the AC neutral phase and the next 2 pins are used to connect the Current Transformer (CT).

### 3) Relay Module

In the relay module, there are 3 input pins namely VCC is used as a current input pin of 5V, GND is used as grounding and IN1 is used as a data input connected to NodeMCU. The output of the relay has 3 pins called Normally Open (NO), COM and Normally Closed (NC). The working system of this relay is that when it is turned on for the first time, the relay is activated when the input is LOW and the output is NO and if the relay input is HIGH and the relay output is NC. In the installation that the researcher made, the relay output pin is connected to the third phase cable, namely the NO and NC pins connected to the phase cable which is connected to the exchange switch.

The experimental results of the design of the electrical installation monitoring system use the Blynk android OS application and can be seen via the website as a monitoring medium. In monitoring the power that is being used or not it will automatically appear in the Blynk application with a duration that varies from time to time because it depends on the network connection. The stability of the internet network greatly affects the maximum results of the data monitoring system. Vice versa, if the internet connection is unstable, the duration of time received for commands given through the application for the control system will take a long time to run or it may even fail to send data to the user, on the monitoring screen display will also affect the appearance of power usage data on the burden. Whereas in the use of a manual control system that is carried out on an exchange switch, there are no obstacles or any duration of time that occurs because the function of this exchange switch is only to disconnect or connect the flow of electric power manually.

In this monitoring system, we can see the power usage of the load used such as the use of lights or other electronic devices so comparisons in load power usage can be seen in table 4.2 which displays a comparison of power in manual measurements and automatic measurements using the Blynk application. The formula used to calculate power manually is the basic formula for calculating power.

$$P = V \times I$$

Formula description:

P = Power (W)

V = Voltage (V)

I = Current (A)

The Blynk application also displays the energy used in the load with kWh units automatically in the application. Energy serves as a medium for calculating the amount of power used at a certain time. Energy has a unit value of joules (J) which has its value, namely:

$$1 \text{ Wh} = 3.600 \text{ J}$$

Or

$$1 \text{ J} = 0.000277 \text{ Wh}$$

1

## CONTROL AND MONITORING SYSTEM DESIGN OF INTERNET-BASED ELECTRICAL INSTALLATIONS

As for calculating the amount of electricity used in the load, you can use the basic formula, namely:

$$E = P \times t \quad 2$$

Formula description:

E = Energy (Wh)  
P = Power (W)  
t = Time (h)

An example is known in the use of power in a house of 57.2 watts for 1 hour, the question is how much kWh of energy is used in the house?

### **Solution :**

Is known :

P = 57.2 Watt

t = 1 jam

Asked: W?

Answer:

W = P x t

W = 57.2 Watt x 1 jam

W = 57.2 Wh = **0.057 2 kWh**

The comparison of the results of current measurements that have been carried out in this study is a comparison of manual measurements and measurements using the Blynk application for monitoring. In manual measurements using an AC current multimeter the comparison of data monitored in the use of electric power manually and using the Blynk application can be seen in Table 4.5 with data calculations using the relative error formula in percentage (%) [10].

$$Error = \left| \frac{V - M}{M} \right| \times 100\%$$

Formula description:

Error = Measurement data error

V = Actual manual measurement data

M = Blynk application measurement data

The results of manual calculations to determine power consumption and load energy use the formulas (1), and (2). The calculation of power and energy can be seen in table 4. While the formula in equation 3 is used to determine the percentage of error data comparison to manual measurements and measurements using the Blynk application.

**CONTROL AND MONITORING SYSTEM DESIGN OF INTERNET-BASED ELECTRICAL INSTALLATIONS**

Table 4. Comparison of manual electric current measurements and automatic measurements using the Blynk application

Burden			Manual Measurement			Measurements on the Blynk Application			Error Data (%)
Lamp 1	Lamp 2	Lamp 3	IN	A	Kwh	IN	A	Kwh	
220 - 240 V / 40 W	220 - 240 V / 25 W	220 - 240 V / 40 W							
0	0	0	0	0	0	0	0	0	0
0	0	1	57.2	0.26	0.0572	55.10	0.25	0.0551	1.04
0	1	0	26.4	0.12	0.0264	24.30	0.11	0.0243	1.09
0	1	1	90.2	0.41	0.0902	92.40	0.43	0.0924	0.95
1	0	0	41.8	0.19	0.0418	40.60	0.19	0.0406	1.00
1	0	1	72.6	0.33	0.0726	74.20	0.35	0.0742	0.94
1	1	0	55	0.25	0.055	62.90	0.29	0.0629	0.86
1	1	1	118.8	0.54	0.1188	114.90	0.53	0.11409	1.02

In the calculations in Table 4 the researcher explains that the calculations are carried out by turning on and off 3 lights alternately so that in the test there are eight conditions. The statement that the condition of the light is on is symbolized by 1 and the statement that the condition of the light is off is symbolized by 0. Comparison of the results from measurements using the Blynk application is obtained not too far from manual measurements using the multimeter measuring instrument so it can be concluded that the percentage of error in measurement is low or it does not reach more than 3% so that the use of this tool is feasible [11].

#### 4.3. Discussion of Electrical Installation Monitoring Control System Tools Internet of Things

In general, research on the design of this control and monitoring system functions as a media tool that functions to reduce people's worries about using electricity at home when traveling or when they are outside the home so that with this tool, the person can control the use of electrical devices from a distance. remotely using a smartphone through the Blynk application as a control medium in turning on and turning off electricity on loads such as house lights, fans, televisions, and so on. Users can find out how the control system is running according to the instructions given by viewing the monitoring page on the Blynk application which displays voltage, current, power, and energy flowing at the load.

Manual electricity usage can be identified through the Blynk application on the monitoring page which automatically detects electric current and can be turned off via the Blynk application if electricity usage is not desired. The control and monitoring system can be carried out without any distance limits in its use so that users can carry out monitoring anywhere, both within the country and users who are abroad, the main requirement is to be connected to the internet network. The internet speed used on this tool is also very influential on the work system of this control device, if the implementation of this tool uses slow internet or a bad connection, the work system of this tool will work slower in carrying out the commands given or a failure may occur in executing the command. system error". The current measurement accuracy that appears in the monitoring application can be compared to direct measurements using a current

meter with the same results.

As for the use of control system tools and monitoring of electrical installations, there are still deficiencies so the use of this tool requires several revisions to maximize the use of these tools, namely:

1. When using electricity manually, the application only detects the current that appears on the monitoring screen without knowing which point the electricity is being used, so we have to see and turn on one control button at a time in the application so that later it will display the cut-off current.
2. Using this tool requires a strong and stable network to maximize the monitoring process and control system in the network.

Comparison of research results from previous studies with the results of research on the design of electrical installation control and monitoring systems is that the accuracy of calculations in monitoring electricity usage at load has a data error value of 0.94 – 2.00%. For the use of the control system itself, it has an average value in carrying out the commands given, which has a speed of 0.9 seconds. Meanwhile, the test results of Riny Sulistyowati and Dedi Dwi Febriantoro in the comparison of current calculations have an average value of 4.88% and an average comparison of electric power monitoring of 2.76%. The work system of this study is repeated calculations, if the control and monitoring system is not being used, the data calculation system starts from 0 again.[12] The results of the tests carried out by Kurniawan were testing the feasibility of the control system tool which obtained an average comparison value of 97.14%, but this study only tested the feasibility system without monitoring so the drawback of this research was the limited use of the control system because if the user gives the order to turn on or turn off the load on the control system outside the home, the user will not know whether the control system is running or not.[13]

## **5. Conclusion**

The work system of this control device can be done manually and using the Blynk application that has been programmed on NodeMCU to turn on or turn off the use of electric current on the load. Using electricity manually can be done by pressing the ON/OFF button on the exchange switch installed. Meanwhile, the use of the Blynk application functions as a medium that can be used to turn on or turn off the use of electric current remotely. The results obtained in this study are that the work system of this control device can work with the work system of the physical exchange switch and the control media system through the Blynk application. So that the existence of this control media can help consumers control electricity usage remotely and can save electricity usage costs.

The monitoring system in this control and monitoring system design tool will display a power monitor automatically on the Blynk application when the control system is activated in the application or activated manually using a switch. The resistance in measuring the power usage of electricity obtained from the comparison of monitoring which is done manually using amperage pliers and automatic measurement using the Blynk application is 0.95 – 2.00% which is carried out 8 times in testing so that the use of this control and monitoring system design can be declared feasible to use.

## **References**

- [1] Dhenny Rachman, Smart Home Monitoring & Control System Using Internet Messaging Infrastructure, Journal Link, Vol. 26, No. 1 February 2020, p.1.

## CONTROL AND MONITORING SYSTEM DESIGN OF INTERNET-BASED ELECTRICAL INSTALLATIONS

- [2] Wayan Sudiarsa, Performance Analysis of Internet of Things Based on Firebase Real-Time Database, Resistor Journal, Vol.6, No 1 – April 2019, p.7.
- [3] Samuel J Kalukar, Lighting Installation Design in Multi-Functional Buildings, Electrical Engineering E-journal, 2015, p.12.
- [4] Rahmat Arofah Hari Cahyadi, Development of Teaching Materials Based on the ADDIE Model, Halaqa: Islamic Education Journal, Vol.3, No.1 June 2019, p.36-37.
- [5] Conference Proceeding/Workshops Haoxiang Wang, Inventive Systems and Control Proceedings of ICISC 2021, (Singapore: Springer Nature 2021) p.826 Monograph, edited book, book
- [6] Hari Santoso, Monster Arduino 2: A Practical Guide to Arduino for Beginners, (Jakarta:Elangsakti.com, 2017), p. 76-77
- [7] Najib Amaro, Electrical Quantity Monitoring System Using IoT (Internet of Things) Technology, (Thesis: University of Lampung 2017), p.2
- [8] Nurul Hidayati Lusita Dewi, Nurul Hidayati Lusita Dewi. Prototype smart home with the NodeMCU ESP8266 module based on the Internet of Things (IoT). 2019. Ph.D. Thesis. Majapahit Mojokerto Islamic University.
- [9] Sasi Agustoni, Tips to Save on Electricity, (Griya Kreasi 2017), p.13.
- [10] Steven J. Leon, Book Translation of Linear Algebra and Its Applications, (Jakarta: Erlangga 2001), p. 363
- [11] Syarkawi M.S Sanggo, Communication for sending Smart Grid Data Using GPRS, (Bandung: UNIKOM Library 2017), p. 40.
- [12] Riny Sulistyowati and Dedi Dwi Febriantoro, Design of a Prototype Control System and Monitoring of Microcontroller-Based Electrical Power Limiters, Journal of Science and Technology, Vol 16 No.1 May 2012, p. 24
- [13] Kurniawan, Design of Internet Of Things (IoT) Based Lighting Installation Tools in Electrical Installation Engineering Courses, Thesis, 2021, p. 44.

## DESIGN OF PLC-BASED ELECTRIC MOTOR CONTROL TRAINER IN COURSES ELECTRIC MACHINERY CONTROL PRACTICE

Mirza Sultan Farza<sup>1</sup>, Malahayati<sup>2</sup>, and Muhammad Ikhsan<sup>3</sup>

<sup>123</sup>Electrical Engineering Education, Tarbiyah and Teacher Training Faculties,  
Ar Raniry State Islamic University, Darussalam, Banda Aceh City, 23111, Indonesia

<sup>1</sup>E-mail: 180211028@student.ar-raniry.ac.id

### Abstract

PLC-based Electric Motor Control is one of the materials in the Electrical Machine Control Practicum course which requires a medium to make it easier for students during practicum. This trainer and practicum module were developed as a tool for teaching lecturers in explaining PLC-based electric motor control material. The PLC trainer in this study used the Zelio PLC module type SR2 B201FU. This study used the research & development method both in the design of the trainers and in the preparation of the PLC practicum modules. The research instrument carried out by the researcher was a media expert and material expert validation sheet to test the feasibility of the trainer to be applied in the Electrical Machine Control Practicum. The questionnaire was used to find out the respondents' responses regarding the importance of using trainers and PLC-based electric motor control practicum modules in the Electrical Machine Control Practicum course. The validation results of media experts and material experts prove that the trainer and PLC-based electric motor control practicum module are very feasible in terms of media and material. Based on the percentage of scores obtained from media experts, namely 91% and material experts obtaining a score of 98%, it is included in the very feasible category to be applied in the Electrical Machine Control Practicum course. The results of student respondents' responses related to the importance of using trainers and PLC modules obtained results of 87% included in the very important category to be applied in practicum.

**Keywords:** *Design, PLC, Trainer, Electric Motor Control, Practicum Module.*

### 1. Introduction

Education is a learning of skills, knowledge and habits of a group of people passed down from one generation to the next through a system of teaching, training or research. With the rapid development of technology at this time, various kinds of technologies have sprung up, starting from newly discovered technologies, to previous technological developments. Especially in the field of control of 1-phase and 3-phase electric motor controllers. At present the process in the control system is not only in the form of manual circuits, but many industries already use the PLC (Programmable Logic Controller) system and this control system is also implemented in the Electrical Machine Control Practicum course. PLC-based Electric Motor Control is one of the materials in the Electrical Machine Control Practicum course which requires a medium to make it easier for students during practicum. This trainer and practicum module were developed as a tool for teaching lecturers in explaining PLC-based electric motor control material [1].



## DESIGN OF PLC-BASED ELECTRIC MOTOR CONTROL TRAINER IN COURSES ELECTRIC MACHINERY CONTROL PRACTICE

Based on the results of initial observations, there were 54.5% of students in the 2019 Electrical Engineering Education Faculty of Tarbiyah and Teacher Training UIN Ar-Raniry Banda Aceh who had attended the Electrical Machine Control Practicum course said that material regarding PLCs was difficult to understand if they did not use a media trainer, while 45.5% said they did not understand at all starting from the delivery of the theory or during the monitoring. Given these problems, this research was made with the aim of designing trainers and compiling PLC-based electric motor control practicum modules and to test the feasibility of trainers as auxiliary media in the Electrical Machine Control Practicum course.

The research method used is the research & development method both in the design of trainers and the preparation of PLC practicum modules. Research and development is a process or research steps that are used to produce certain products as well as test the effectiveness of these products [2].

In designing this trainer using PLC Zelio SR2 B201FU. The wiring path from the PLC is connected directly to the banana port as the output from the PLC port itself. There are 14 ports connected to the PLC port with bananas [3]. The ports in question are L, N, I1 to I6 and Q1 to Q3, each of which has 2 switches. The results of the design can be seen in Figure 2 and Figure 3.

### 2. Method

This research uses the research and development (R&D) method. The instruments used to collect data in this study are validation sheets and questionnaires. To analyze the data resulting from validation, researchers use (1).[4]

$$\text{Percentage} = \frac{\text{Total Value Total}}{\text{Total Maximum Score}} \times 100 \quad (1)$$

The stages used in this study are as follows:

#### 1. Potential Problems

Based on the results of observations made in the Electrical Machine Control Practicum course, students do not understand clearly about PLCs so that the learning process becomes less effective.

#### 2. Collection of Information

Trainers designed by researchers aim to help the learning process to be more effective. The tools and materials used are:

- a. PLC Zelio is the main component that will be used as the trainer
- b. Banana Plug Connector as port output.
- c. Test Pen is a tool to determine an electric voltage in a conductor, and as a tool to strengthen PLC port bolts.
- d. Combination pliers as a tool that can hold, grip and twist and cut wires and other objects.
- e. Plus screwdriver equipped with a rubber coated handle or insulator to keep it safe while working.
- f. NYAF cable 0.75 mm as a conductor of voltage and electric current.
- g. Solder and tin to attach the NYAF cable to the banana connector inductor plate.
- h. Plywood measuring 23 x 30 cm as a trainer cover.
- i. 14 mm drill and drill bit.

#### 3. Trainer Design

Before designing it into a real form, first design a sketch of the trainer using

## DESIGN OF PLC-BASED ELECTRIC MOTOR CONTROL TRAINER IN COURSES ELECTRIC MACHINERY CONTROL PRACTICE

Microsoft Visio 2016 software. The researcher designed this trainer by placing the Zelio PLC on plywood measuring 23 x 30 cm (the front cover of the trainer) which has been given space to show the PLC screen and buttons as well as banana connectors that are attached to each PLC port with a size of 14mm as output from each port, namely L/N, I1 to I6 and Q1 to Q2 (switch 1 and switch 2) on the PLC. The design of the trainer and its description can be seen in Figure 1 [5].

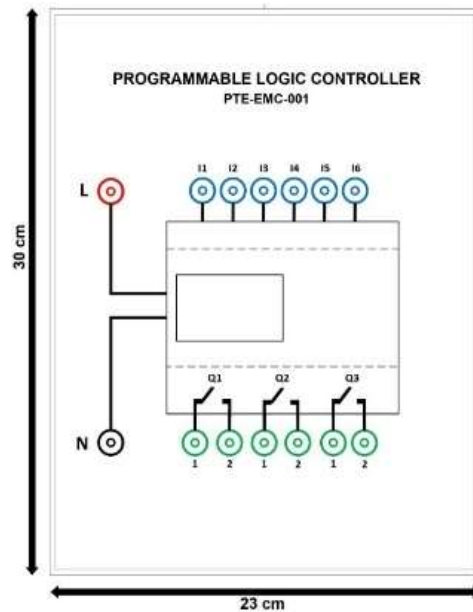

Figure. 1. PLC trainer design.

### 4. Validation of Trainers

Validation of trainers and practicum modules is carried out by validation of material experts and media experts to see the feasibility of trainers and practicum modules [6].

### 5. Trial of Trainers

Trials of trainers and practicum modules were carried out by 13 students as respondents in response to the use of trainers and practicum modules.

## 3. Literature Study

Literature study contains a description of the results of previous research on issues to be studied as an accurate source to guide research writing.

- Hesti Istiqlaliyah, with the title "Analysis of the Effects of Using a Star Delta System with Manual and PLC Circuits on 3 Phase Electric Motors" in 2017. This research used the Research and Development (R&D) method. The results of his research prove that there are several differences in the use of circuits between PLC systems and manual systems, namely the PLC system is more practical, simple, reliable, easy to program, but quite expensive and more difficult to maintain.
- Hariyanto, Didik Aribowo and Mohammad Fatkhurrokhman, with the title "Development of 3 Phase Motor Control Kit Trainer Learning Media in Electric Motor Installation Subjects at SMKN 4 Serang City" in 2020. This research used

## DESIGN OF PLC-BASED ELECTRIC MOTOR CONTROL TRAINER IN COURSES ELECTRIC MACHINERY CONTROL PRACTICE

the Research and Development (R&D) method. The results of his research prove that the effectiveness of the trainer kit learning media for controlling 3-phase motors and electric motor installation jobsheets results in a pre-test value of 56.73 and a post-test value of 87.82, so there is an increase in learning outcomes after using learning media with n-gain obtained 0.73 which fall into the category of "high effectiveness".

### 4. Result and Discussion

#### a. Research Results

##### 1). Results of Trainer Design

In designing this trainer using PLC Zelio SR2 B201FU. The wiring path from the PLC is connected directly to the banana port as the output from the PLC port itself. There are 14 ports connected to the PLC port with bananas [7]. The ports in question are L, N, I1 to I6 and Q1 to Q3, each of which has 2 switches. The results of the design can be seen in Figure 2 and Figure 3.

The operation of the PLC trainer requires a guide in the form of a module that contains code and programming methods so that the PLC can carry out commands according to the desired program. Some of the material contained in the PLC practicum module contains material on electric motor control, namely PLC-based Direct On Line starting, PLC-based automatic alternating live load circuits, PLC-based interlocking circuits and PLC-based forward reverse circuits.[4] The practicum module is also equipped with how to install the PLC onto an electric motor, how to operate the PLC to be programmed, and the PLC program code with a ladder diagram language type [8].



Figure 2. Front view of PLC trainer design results.

## DESIGN OF PLC-BASED ELECTRIC MOTOR CONTROL TRAINER IN COURSES ELECTRIC MACHINERY CONTROL PRACTICE

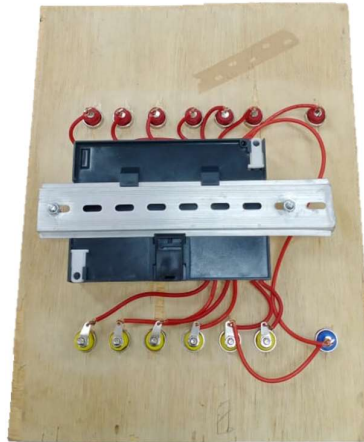

Figure. 3. PLC Wiring Line to Banana port from behind.

### 2). Results of Validation

The validation results were obtained based on the validation instruments of material experts and media experts which were given to two validators. Based on the results of media validation, the total score is 32 with a maximum value of 35 and the eligibility percentage results are 91% with the category "Very Eligible" for use in the Electrical Machine Control Practicum course.

Based on the results of the material validation, it was obtained that the total score was 44 with a maximum total value of 45 and obtained a feasibility percentage of 98% with the "Very Eligible" category.

### 3). Results of Trial of Trainers and Practical Modules for PLC-Based Electric Motor Control

Trials were conducted to see responses from respondents on the importance of using trainers and practicum modules. The respondents in the PLC trainer trial and practicum module were students in semester VII who had taken the practicum course on controlling electrical machines in the Electrical Engineering Education Study Program, Faculty of Tarbiyah and Teacher Training, UIN Ar-Raniry Banda Aceh, totaling 13 students. Based on the results of respondents' responses per indicator regarding the importance of using trainers and PLC-based electric motor control practicum modules, a total score of 624 was obtained from 13 respondents with a maximum value of 715 and the percentage value obtained was 87% with the "Very True" category. To be used as one of the materials that can be applied in the Electrical Machine Control Practicum course.

Based on the results of individual respondents' responses regarding the importance of using trainers and PLC-based electric motor control practicum modules in the Electrical Machine Control Practical course, the total score was 624 out of 13 respondents and the maximum total score was 715 with a percentage value of 87% with category "Very True".

### b. Discussion

Based on the results of the media validation test, it obtained a percentage value of 91%, while the results of the material validation obtained a percentage value of 98%. So in terms of media and material, the feasibility of the Trainer and the PLC-Based

**DESIGN OF PLC-BASED ELECTRIC MOTOR CONTROL TRAINER IN COURSES ELECTRIC MACHINERY CONTROL PRACTICE**

Electric Motor Control Practicum Module received the "Very Eligible" category to be applied to the Electrical Machine Control Practicum Course. The graph can be seen from Figure 4.

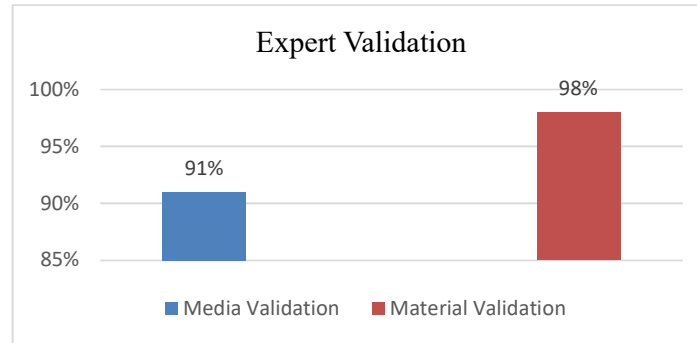

Figure. 4. Graph of Media Expert and Material Expert Validation Results.

From the results of the respondents' responses which had been processed by the researchers, they obtained different percentage results for each indicator. If you look more closely, the time efficiency indicator is at a lower percentage level of 85% compared to the material presentation indicator of 87%, learning outcomes of 88%, and benefits of 88%. The graph can be seen from Figure 5.

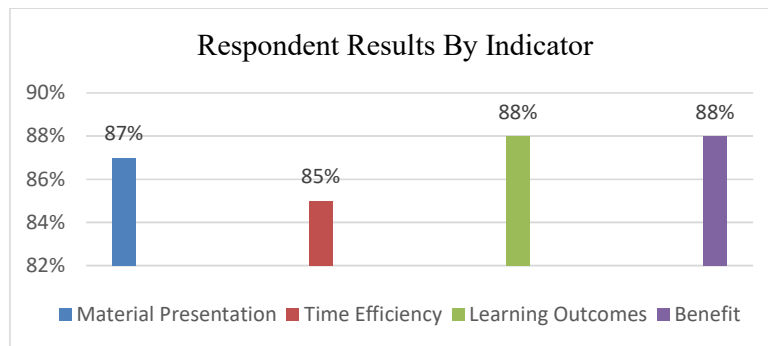

Figure. 5. Graph of Respondent Results by Indicator.

Media validation results give a value with a total score obtained is 32 with a maximum total score of 35 and obtains a feasibility percentage of 91% based on the calculation formula. the category of trainer eligibility percentage level indicates that the PLC trainer gets the "Very Eligible" category for use in the Electrical Machine Control Practicum Course. For details of validation can be seen in table 1.

TABLE 1 MEDIA VALIDATION TEST RESULTS

Indicator	Statement item	Value Criteria
General View	Statement 1	4
	Statement 2	4
	Statement 3	5
Practical	Statement 4	5
	Statement 5	5

**DESIGN OF PLC-BASED ELECTRIC MOTOR CONTROL TRAINER IN COURSES ELECTRIC MACHINERY CONTROL PRACTICE**

Quality	Statement 6	4
	Statement 7	5
Total Score		32
Percentage		91%

The results of the material validation the validator gives a value with a total score obtained is 44 with a maximum total value of 45 obtaining a feasibility percentage of 98% based on the calculation formula. then the results of the material validation test showed that the trainer and the PLC-based electric motor control practicum module received the "Very Eligible" category to be applied to the Electrical Machine Control Practicum course. For details of validation can be seen in table 2.

TABLE 2 MATERIAL VALIDATION TEST RESULTS

Indicator	Statement item	Value Criteria
Material	Statement 1	5
	Statement 2	4
	Statement 3	5
Time	Statement 4	5
Purpose	Statement 5	5
	Statement 6	5
	Statement 7	5
Benefit	Statement 8	5
	Statement 9	5
Total Score		44
Percentage		98%

The results of respondents' responses based on indicators related to the importance of using trainers and PLC-based electric motor control practicum modules obtained a total score of 624 out of 13 respondents with a maximum value of 715 and the percentage value obtained was 87% and was in the "Very important" category to be used as one of the material and applied when the practicum course is carried out. For details of the responses can be seen in table 3.

TABLE 3 RESPONDENT RESULTS BY INDICATOR

Indicator	Item Number	Value Criteria					Total	Percentage by Item	Percentage by Indicator
		1	2	3	4	5			
Material	1	0	0	0	7	6	58	89%	87%
	Presentation	2	0	0	1	8	4	55	
Time	3	0	0	1	8	4	55	85%	85%
	Efficiency	4	0	0	0	9	4	56	
Purpose	5	0	0	1	5	7	58	89%	88%
	6	0	0	1	8	4	55	85%	
	7	0	0	1	3	9	69	92%	
	8	0	0	2	6	5	55	85%	
Benefit	9	0	0	0	8	5	57	88%	88%
	10	0	0	2	5	6	56	86%	
	11	0	0	0	6	7	59	91%	
Total Score and Total Percentage							624		87%

The results of individual respondents' responses also obtained the same results as the calculation results and the total score obtained was 624 out of 13 respondents and the maximum total score was 715 with a percentage value of 87% and was in the

## DESIGN OF PLC-BASED ELECTRIC MOTOR CONTROL TRAINER IN COURSES ELECTRIC MACHINERY CONTROL PRACTICE

"Very Important" category. For individual details can be seen in table 4

TABLE 4 RESPONDENT RESULTS BY INDIVIDUAL

Name	Total Value Criteria	Percentage
Respondent 1	48	87%
Respondent 2	43	78%
Respondent 3	44	80%
Respondent 4	50	91%
Respondent 5	44	80%
Respondent 6	52	95%
Respondent 7	52	95%
Respondent 8	52	95%
Respondent 9	46	84%
Respondent 10	49	89%
Respondent 11	46	84%
Respondent 12	46	84%
Respondent 13	52	95%
Total Score and Total Percentage	624	87%

### 5. Conclusion

This study aims to produce modules and trainers that can assist the learning process. The validation results of media experts obtained a percentage of 91% and material experts obtained a percentage of 98%. Based on the results of the validation by media experts and material experts, it was shown that the PLC trainer and practicum module were "Very Eligible" applied to the Electrical Machine Control Practicum course.

The results of the respondents' responses from 13 students obtained a percentage of all indicators of 87%, so the respondents' responses stated that the PLC trainer and practicum module were "Very important" to be used in the Electrical Machine Control Practicum course.

### References

- [1] H. Istiqlaliyah, "Analisis Pengaruh Penggunaan Sistem Star Delta dengan Rangkaian Manual dan PLC pada Motor Listrik 3 Phasa," *Al Jazari Journal of Mechanical Engineering*, vol. 16, no. 21, 2017.
- [2] Sugiyono, "Metode Penelitian Kuantitatif Kualitatif dan R&D", Alfabeta, 2013.
- [3] J. Hampson and S. Hanssen, "Electrotechnology Practice," Australia: Cengage Learning Australia, 2019.
- [4] S. L. Herman, "Electrical Wiring Industrial," United States of America: Cengage Learning, 2020.
- [5] C. M. Franchi, "Electrical Machine Drives: Fundamental Basics and Practice," Britania Raya: CRC Press, 2019.
- [6] S. L. Herman, "Electrical Wiring Industrial," United States of America: Cengage Learning, 2020.
- [7] A. Rukajat, "Pendekatan Penelitian Kuantitatif. Quantitative Research Approach," Deepublish, 2018.
- [8] R K. Ningsih and Sukardi, "Pengembangan E-Modul Trainer Kontrol Motor Listrik dan PLC di Sekolah Menengah Kejuruan," *Jurnal Pendidikan Teknik Elektro*, 2021

# HAZOP METHOD FOR ELECTRICAL K3 ANALYSIS SETTLEMENT IN THE VILLAGE JAGONG JEGET-ACEH TENGAH

Raihan Islamadina <sup>1)</sup>, Ike Wirda Sari <sup>2)</sup>, Hadi Kurniawan <sup>2)</sup>

<sup>1)</sup> Pendidikan Teknologi Informasi, Universitas Islam Negeri Ar-Raniry Banda Aceh

<sup>2)</sup> Pendidikan Teknik Elektro, Universitas Islam Negeri Ar-Raniry Banda Aceh

E-mail: [raihanislamadina@ar-raniry.ac.id](mailto:raihanislamadina@ar-raniry.ac.id)

## Abstract

Electrical energy is something that is very important today and is very much needed for every house or place of residence. Every house stay must have safety in electrical installations installed such as MCB, grounding, fuses, and other electrical fittings that are included in K3 electricity, so that the house can be said to be safe to live in. However, there are still many residents who do not know about the existence of PUIL for the electrical installations used and installed in their homes, as well as minimal knowledge of the importance of PUIL completeness. This study aims to determine the completeness of residents' electrical installations based on PUIL (General Electrical Installation Requirements) in Jagong Jeget village -Aceh Tengah by using HazOp so that residents' homes avoid hazards caused by electric currents. HazOp is an abbreviation for method *Hazards and Operability*. this research uses a qualitative method with interview, observation, and documentation techniques. The result, there are several residents' houses that are still there using a fuse as a safety installation, and there are still many residents' houses that do not install grounding, as well there are some residents who use electronic devices not following for under the power installed in their homes. So, got concluded that house residents in Jagong Jeget Village-Aceh Tengah yet fulfill standard PUIL equipment.

**Keywords:** *hazards, operability, K3, electrical installation*

## 1. Introduction

Genre electricity holds a role important inside life society. Electricity is used almost in all aspects of life people human. Electricity has Lots of benefits and functions that can help the man carry out activities every day. However, in terms of system installation electricity, and power burden in use equipment electricity is still not yet lots known by the public. Though, should the installation of electricity must follow PUIL (General Electrical Installation Requirements) and must be supervised by K3 (Occupational Safety and Health). Is done as an effort to minimize possible danger happening in no time unexpected.

The danger is often found in the use of electricity every day, like houses without a tool extinguisher firing early, tool electronic with burden exceeding KWh that has been installed, fan wind dusty, problematic AC, and installation on the floor. Problems with electricity can resulted in several frequent accidents found, like connection short current literal, stung current electricity, and frequent MCB (*Miniature Circuit Breaker*) back and forth because of excess load.

Hazards and impacts that can be identified using HazOp. HazOp is an abbreviation



for method *Hazards and Operability*. *HazOp* is a method of identifying systematic and structured hazards to evaluate the level of risk in something system frequently unsafe *conditions* found at home, such as no There is tool extinguisher fire early, tool electronics that have burden more from KWh that has installed, fan dusty wind, problematic AC, and installation on the floor. *HazOp* is also one method used in countermeasures disaster in safety and health work. Safety and health work is also an application technique management safety and health arranged work in Constitution Number 01 of 1970 concerning Safety Work and Act Number 13 of 2003 concerning Employment. So that, with existing *HazOp*, crash work can be identified in a manner more early.

Study This was conducted in Village Jagong Jeget Aceh Tengah, with the objective for analyze the completeness condition of general installation electricity (PUIL) at home residents, as well determine factors *HazOp* on installation electricity as well as level risks that occur. This was done because in the village this once happen believed fire happen because the current connection was scorching short several many house residents, so resulted in a loss with enough nominal big for affected residents fire in a manner direct.

## **2. Method**

The flow of research conducted to know the appropriateness of system installation electricity at home inhabitants or settlements showed in Figure 1. Research This adopted type of study qualitative through data collection and later analysis interpreted by following per under approach descriptive. The study uses a method qualitative based on an approach descriptive aim to describe or explain something phenomenon or social happenings in society. Use method descriptive form data collection and analysis in the field based on moderate facts happened on the spot study the. Study This was carried out in the Aceh area, precisely in Village Jagong Jeget, Aceh Tengah. subject from study This is 77 households housing units citizens, one office village, and one mosque.

The process stages study *HazOp* has done is as follows:

1. Observation is an activity carried out by researchers to observe electrical installations in residents' homes.
2. The formulation of the problem is the main problem that will become the title and purpose of this research.
3. Data collection techniques are methods used by researchers to obtain the data needed for research to analyze the data to produce results.
4. *Library Research* is a data search process that can be used to support research through books, journals, and important documents.
5. *Field Research* is a research process to obtain data by observing natural phenomena that occur around the scope of research.
6. Data analysis is the process of filtering the data that has been obtained to conclude.
7. The results of the research are data obtained after going through the process of searching and filtering data.
8. The conclusion is the final result of the research that has been carried out by utilizing the data that has been obtained and filtered.

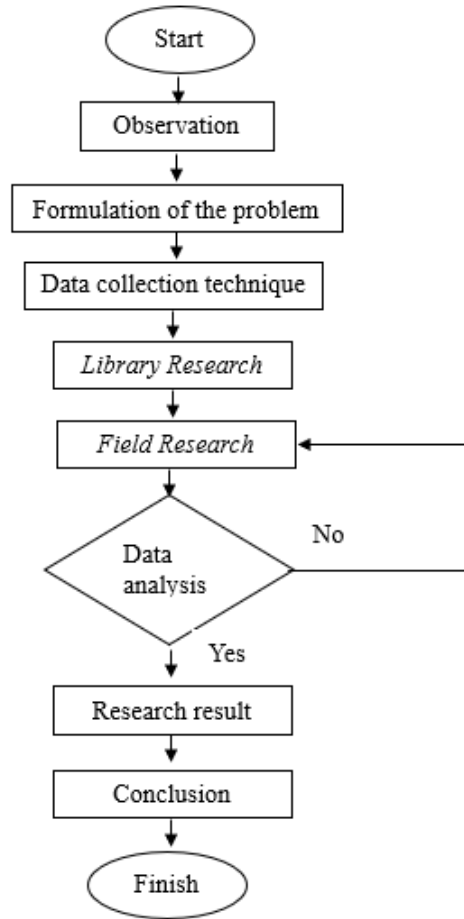

Figures. 1. Research flow HazOp

Data collection was carried out in three-way, namely:

i. Interview

In doing the interview, a researcher still must have limited interesting conclusions from side conversations that took place. The interview instrument grid was conducted in Table 1.

TABLE 1 INSTRUMENT INTERVIEW

Formula Problem	Indicator	Question Items
How HazOp (Hazard and operability) can role in Engineering Electrical Installation, as well What relation to the room scope of K3 (Safety and Occupational Health)?	Know installation electricity House inhabitant or know PUIL provisions will power used at home the as well as What it's Hazop in Electrical Installation Engineering and Installation Engineering and What it K3 (Occupational Safety and Health)	<ol style="list-style-type: none"> <li>1. Is a citizen do you know about the PUIL provisions installed in the house?</li> <li>2. Is there any implementation of HazOp (safeguards) in installation of electrical installations in house?</li> <li>3. A whether HazOp should be in installation electrical installation homes?</li> <li>4. By using the method HazOp whether a work accident or fire can be handled</li> <li>5. On installation electrical installation at home relating to K3 (safety and occupational health)</li> </ol>

ii. Observation

Observation is a systematic observation and recording of the symptoms being examined. Observations made in study This in the form of: - Equipment home installation citizen, consists of switches, sockets, and fittings; - Security type of MCB and fuse; - Circumstances physique earthing/grounding; and - Circumstances environment House influencing citizens security installation or no.

iii. Documentation

Besides that, qualitative method used For analysis the data was performed through four stages, namely, data collection (*data collection*), data reduction (*data reduction*), data presentation (*data display*), and conclusions.

a. Data Collection (*data collection*)

The data obtained is the result of observations, interviews, and documentation recorded in field notes. This research has a total data of 70 households in the sense that the data does not reach 100, therefore the sampling is carried out 10% - 15%.

b. Data reduction (*data reduction*)

Data reduction is the process of selecting, and simplifying data from records written in the field. Data reduction is the same as summarizing data so that it becomes a more concise summary.

c. Data Presentation (*data display*)

The presentation of data is a summary of information that has been arranged so that conclusions can be drawn. The presentation of data that is often used in qualitative form is narrative.

d. Conclusion

The conclusion is the final stage in data analysis carried out by researchers so that research is easier to understand.

### 3. Results and Discussion

Results obtained from the study in the form of completeness data installation electricity, security installation reviewed electricity from facet condition physical, and selection for safety installation power on house citizen. Processed data is the result data from K3 analysis of electricity in settlements residents use the method HazOp inspection installation electricity, which includes equipment PUIL 2000 at home existing residence completeness installation, type the safety in use, use of grounding or grounding that is installed or not, and the environment or condition place house is built. The result showed in Table 2.

TABLE 2 EQUIPMENT PUIL

NO	Resident name	Equipment Installation			Protection		grounding	Environment
		Switch	Electric socket	fittings	MCB	Fuse		
1	Supriyanto	√	√	√	X	√	X	√

2	Agus	√	√	√	√	X	X	√
3	Mirja	√	√	√	√	X	X	√
4	Amen	√	√	√	√	X	X	√
5	Herman	√	√	√	√	X	X	√
6	Harris	√	√	√	√	X	X	√
7	Sutris	√	√	√	√	X	X	√
8	Sudir	√	√	√	X	√	X	√
9	Harry	√	√	√	X	√	√	√
10	Muhiron	√	√	√	X	√	√	√
11	Hamdan	√	√	√	√	X	X	√
12	Ani	√	√	√	√	X	X	√
13	Anisa	√	√	√	√	X	X	√
14	Village Office	√	√	√	√	X	X	√
15	Mosque	√	√	√	√	X	X	√
	<b>Amount</b>	15	15	15	11	4	2	15

Based on Table 2, the observation data is obtained which produces the following information:

1. The houses in Jagong Jeget Village have an average power load of 900 watt, but there is one house that has a power load of 1320 watt and there are two houses that have a power load of 450 watt.
2. For village offices and mosques in Jagong Jeget Village, each has a power load of 900 watt and 1320 watt.
3. All houses, village offices, and mosques have used *the Miniature Circuit Breaker* (MCB) protection system. The MCB used varies depending on how much power the building has. MCB C2 for 450 watts of power, MCB C4 for 900 watts of power, and MCB C6 for 1320 watts of power.
4. Not all buildings apply *fuse boxes* as an additional tool to prevent accidents, only a few residents' houses do.
5. All residents' houses have electrical equipment that exceeds the power load of the house, but these tools are never used simultaneously to prevent the MCB from bouncing or sudden power outages.

Additionally, based on results from observations and interviews, the average power installed in the house inhabitant is 900 Watt with the average household own equipment electricity with burden power exceeding installed power, so use No Can in a manner together in one time. So as with PUIL equipment. Percentage PUIL completeness shown in Figure 2 is the description from results in Table 1 with the use equation:

$$percentage = \frac{\text{Number of parts}}{\text{Total number}} \times 100\% \quad (1)$$

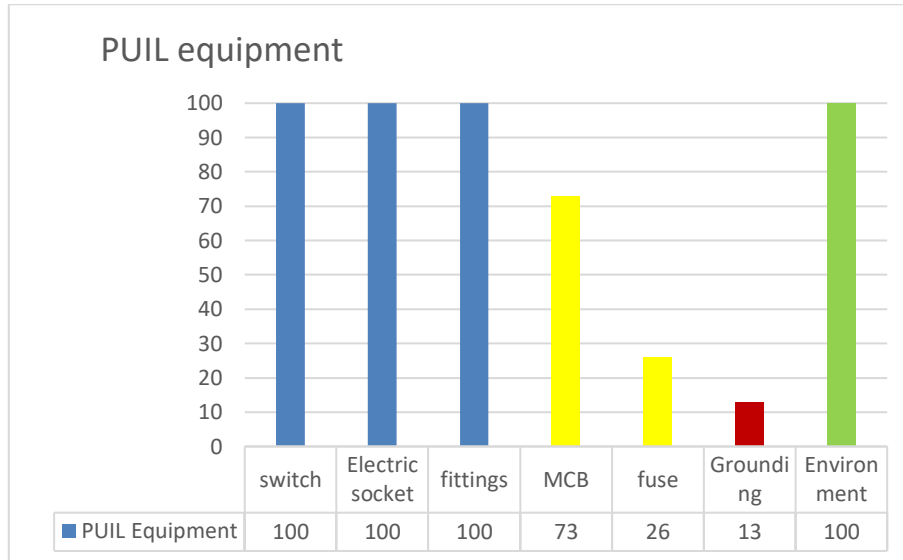

Figures. 2. Percentage of PUIL equipment

By amount sample 15 houses, then for installation house inhabitants produce 100% complete with the use of each house that has switches, sockets, and light fittings. 11 houses are using MCB with percentage 73%. Residents' homes that use protection (fuse) totaling 4 houses with a percentage of 26%. On the grounding section only there is 2 houses inhabitant by whole samples that use it, ie around 13%. Environment House stays enter in class safe because no exists barriers like trees big can annoying genre electricity to the house from system transmission as well as building house built on level ground. So, got concluded that house residents in the village Jagong Jeget – Aceh Tengah yet someone fulfills standard PUIL completeness due to still lots house citizens who don't have grounding caused by a lack of tools in installation.

#### 4. Conclusion

The study used the HazOp method in Jagong Jeget Village-Aveh Tengah to assess the completeness of PUIL in residents' homes, and can determine the protection system that is widely used by residents. The result obtained is that none of the residents' houses in Jagong Jeget village meet the PUIL completeness standards because there are still many residents' houses that do not use grounding. This is caused by a lack of tools in the installation of grounding and the average power used is 900 watt.

## References

- [1] Anggito Albi, D. (2018). *Metodologi Penelitian Kualitatif*. CV Jejak.
- [2] Dani, A. (2021). *Identifikasi Bahaya Menggunakan Metode Hazard and Operability Study (Hazop) Pada Pekerjaan Pemasangan Arrester Teknisi Pekerjaan Dalam Keadaan Bertegangan (Pdkb) Pt. Pln (Persero) Up3 Demak*. 30601700092.
- [3] Fakhruddin, S. (2021). Pengenalan Dan Pengendaian Bahaya Pada Lingkungan Rumah Tangga Kepada Masyarakat Di Desa Mekarsari. *Adibarata Jurnal*, 3(1).
- [4] Indra Z, I. K. (2011). Analisis Sistem Instalasi Listrik Rumah Tinggal dan Gedung untuk Mencegah Bahaya Kebakaran. *Jurnal Ilmiah Elite ElektroElektro*, 2(1), 40–44.
- [5] Ismara, K. I. (2019). Identifikasi Potensial Resiko Kebakaran Dengan Metode Hazard And Operability Study di Bulukumba Tahun 2021. *Jurnal Teknik Elektro*, 7(2), 152–160. <http://journal.student.uny.ac.id/ojs/index.php/elektro>
- [6] Sugiyono. (2016). *Metode Penelitian Kuantitatif, Kualitatif, dan R&D*. Alfabeta.

# DESIGN OF AUTOMATIC UNLOCKING SYSTEMS WITH BASED NOTIFICATIONS RFID (*RADIO FREQUENCY IDENTIFICATION*)

Fathiah <sup>1)</sup>, Sri Wahyuni <sup>2)</sup>, Abdul Malek Safar <sup>3)</sup>

<sup>1,3</sup>Department of Electrical Engineering Education, Faculty of Tarbiyah and Teacher Training, State Islamic University (UIR) AR-Raniry, Indonesia

<sup>2</sup>Department of Informatics Engineering, Faculty of Science, State Islamic University (UIR) AR Raniry, Indonesia

Email: fathiah@ar-raniry.ac.id

## Abstract

Security is the most important thing in everyday life, there are lots of thefts or break-ins of a security system because it is not properly protected. Plus there is no additional notification system on conventional locks that are commonly used which can provide information on anyone trying to access the door. Automatic Unlock System With RFID Based Notification (*Radio Frequency Identification*). Aim to plan *prototype* automatic unlocking system with RFID based notifications. Work system from *prototype* it is controlled using the NodeMCU ESP8266 as the brain of *prototype* which is equipped with RC522 RFID sensors, servo motors, and *Touch* Sensor to open the door from the inside. This study uses a type of qualitative research and uses methods *Research and Development (R&D)*. Based on the test results, the system can read the E-KTP card to open the door and the system can also send notifications to the telegram application. RFID testing is known sensors can read cards starting from distance of 0.0 cm to 1.8 cm. In testing the RFID response time, it is known that the time required ranges from 2.59 to 2.86 *second*. Next test the response time *touch* sensor, the response time required until the door is opened an average of 1.99 *second*.

**Keywords:** *RFID, NodeMCUESP8266, Automatic Lock, Prototype, E-KTP, Sensor*

## 1. Introduction

Science and technology are currently developing very rapidly, including in the field of *electrical engineering*. As we already know, almost all of the manufacturing equipment is already using automatic technology. For example, to open a door that we usually do manually by entering a key, this can be handled with electronic equipment that can open doors automatically by controlling using a card sensor or commonly called RFID (*Radio Frequency Identification*) so that the use of space becomes efficient and increases security in the room. RFID (*Radio Frequency Identification*) is a technology that uses radio waves that can be used to identify a particular object in accordance with what has been programmed in it.

Currently security is also the most important thing in everyday life, there are lots of thefts or break-ins of a security system because it is not properly protected. Plus there is no additional notification system on conventional locks that are commonly used which can provide information on anyone trying to access the door. With the rapid development of today's technology, it is necessary to develop a security system that can eliminate the weaknesses in conventional locks, a lock system is needed that can provide direct

notification to the owner if someone tries to access it.

## **2. Research methods**

### **A. Approach and Type of Research**

This study uses a type of qualitative research and uses methods *Research and Development* (R&D). *Research* means to search again, in other words to carry out investigations in order to obtain facts or data to obtain additional information. Research methods *Research and Development* (R&D) is a research method used to produce certain products and test the product.

#### 1. Potential and Problems

Potential is anything that when utilized will have added value. While the problem is a deviation between what is expected and what happened.

#### 2. Collection of Data or Information

The process of collecting information is carried out factually and can be used as material for planning certain products as expected.

#### 3. Product Design

Product design is a series of efforts to study and plan functional, ergonomic, and aesthetic wearables so that they become more valuable and useful for users.

#### 4. Planning Level

The design stage aims to produce a design that meets the requirements determined after the planning stage.

#### 5. Product Testing

Product trials aim to determine whether the product made is suitable for use or not. Product testing is carried out in three stages, namely:

- a. Testing the distance between the card and the sensor
- b. RFID response time testing (*Radio Frequency Identification*)
- c. Response time testing *touch* sensor.

### **B. Research Stage**

At the research stage, researchers start from the model planning session to the final product to be made. The stages used include:

#### 1. Planning Stage

This stage is the initial stage in designing a shaped product *prototype* automatic unlock system with RFID based notification (*Radio Frequency Identification*) which covers the preparation of tools and materials to be used.

#### 2. Planning *Prototype*

After all the equipment is adequate, a circuit and programming is needed which will be made in the form of a physical circuit and will also be programmed in the computer to be entered into Arduino so that the device can be controlled using Arduino.

#### 3. Product Testing

*Prototype* will be tested starting from testing the distance of the card with RFID (*Radio Frequency Identification*), RFID response time testing (*Radio Frequency Identification*), response time testing *touch* sensor will then be seen the results of *prototype* which has been tested whether everything can run as expected or not.

### **C. Research Flowchart**

Flowcharts are used to describe the algorithms that researchers use in this study. Picture *flowchart* can be seen in Figure 1.



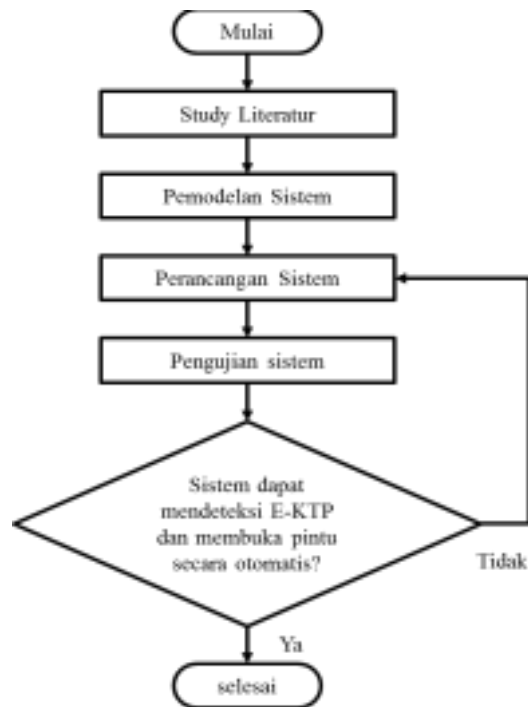

**Figure 1.** Flowchart Research Flow.

#### **D. Research Tools and Materials**

Tools and materials to be used during the design and assembly process *prototype* automatic door opening system with RFID based notification (*Radio Frequency Identification*) as follows:

##### **a. Tools and materials used:**

- a. Gunting
- b. Solder
- c. Glue Shot
- d. Laptop
- e. *Wire stripper* (Cable cutter)
- f. Tang
- g. Software Arduino IDE
- h. *Radio Frequency Identification* (RFID) MFRC-522
- i. Motor servo MG90S
- j. NodeMCU ESP8266
- k. E-KTP
- l. *Touch Sensor* TTP223
- m. Kabel USB

- n. Cablejumper
- o. Solder wire
- p. Isolation

### b. Automatic Door Open Prototype Diagram

Workflow *prototype* open automatic doors are generally designed based on a block diagram, can be seen in figure 2.

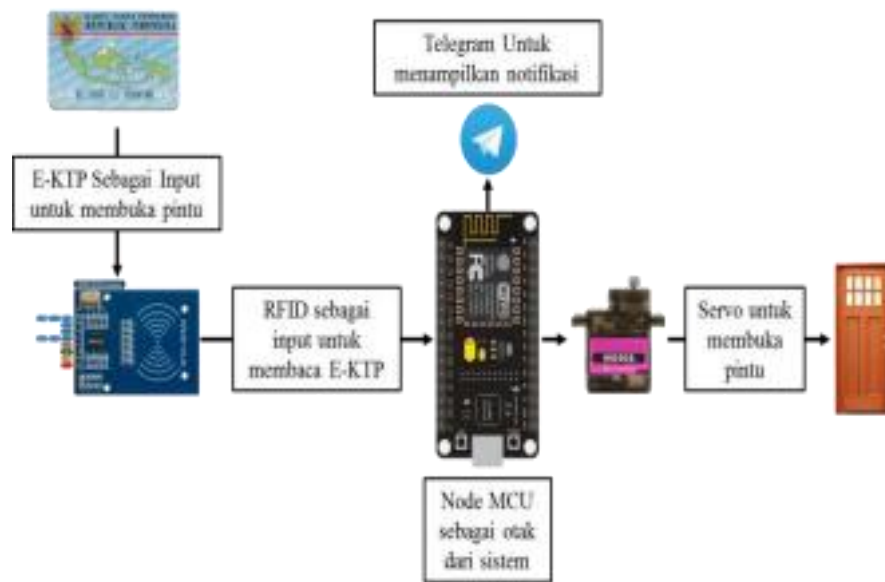

**Figure 2.** Workflow *prototype* open the automatic door.

#### Functions of Each Block

- a. E-KTP: Serves as input to be sent to the RFID reader.
- b. RFID reader: serves to read the ID number contained in the E-KTP chip. Data stored on the chip will be sent via radio waves after *taq* receive radio waves from the reader then the data will be sent to the microcontroller.
- c. NodeMCU ESP8266: functions as a microcontroller and also as a link to the internet network.
- d. Servo: works to open the door when the entered input matches the data in the program.
- e. Telegram application: functions as a media for receiving notifications.

### 3. Discussion and Research Results

#### A. How the Tool Works

The flowchart describes the process flow from *start* to finish. In this case, the work process is regulated by the program that works in the controller. Moment *start*, the program will work and RFID will begin to identify the E-KTP card that is attached.

Data from the card will be read by RFID and sent to NodeMCU ESP8266, if the data

from the card matches the program then the servo will rotate 180° until the door opens and NodeMCU ESP8266 will send a notification to the telegram application in the form of the name of the owner of the E-KTP. If access is denied so that the servo does not rotate and the door does not open, the NodeMCU ESP8266 also sends a notification to the telegram that the card used is not registered.

To open the door from inside the room, you only need to touch a button *touch* sensor without the need to use a card, and when the servo works the door will open automatically.

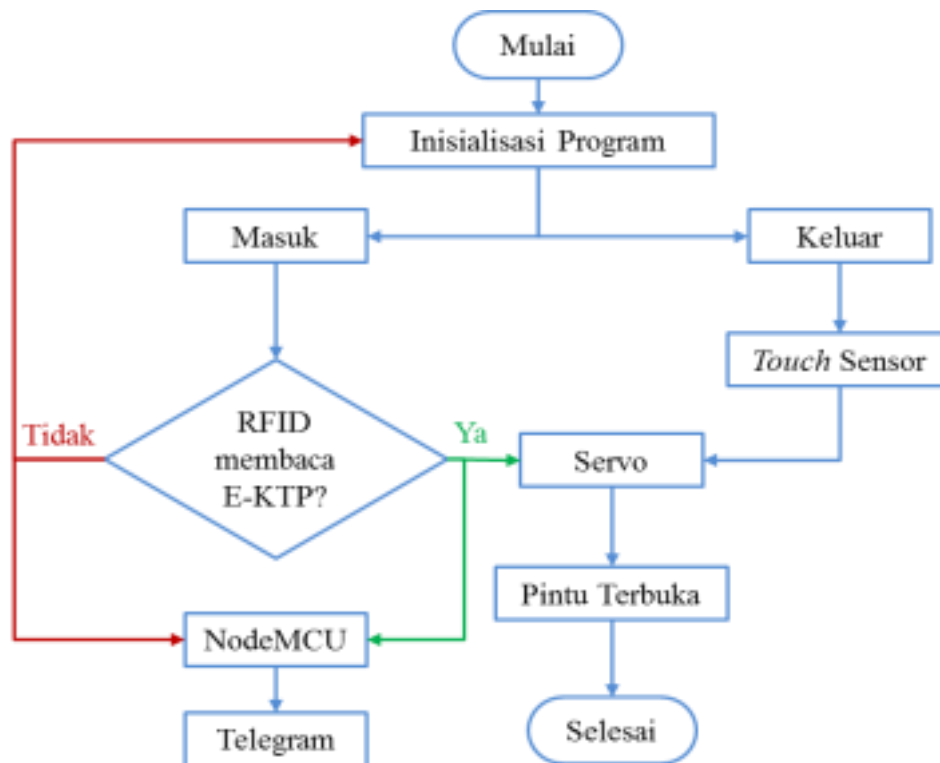

**Figure 3.**Flowchart How the Tool Works.

1. Testing the distance between the card and RFID (*Radio Frequency identification*) RFID testing is carried out by bringing the E-KTP card closer to the sensor, if the RFID sensor reads or identifies the ID number on the E-KTP card according to the program, the servo will rotate 180° degrees so that the door opens.

**TABLE 1.**Testing the distance of the E-KTP card that can be read by the RFID sensor.

Testing to	Card spacing with sensor	Door condition
1	0,0 cm	Open
2	0,5 cm	Open
3	1,0 cm	Open
4	1,5 cm	Open

5	1,8 cm	Open
6	1,9 cm	Closed
7	2,0 cm	Closed

From the test results in table 1 above, it can be explained that RFID can read the chip inside an E-KTP card if the card is brought closer from a distance of 0.0 cm to a distance of 1.8 cm to the RFID sensor.

2. RFID Response Time Testing (*Radio Frequency Identification*) In this test it will be discussed how long the RFID response time is after the card is pasted until the door is opened using 10 samples.

**TABLE 2. RESPONSE TIME TESTING**

Test When	RFID Response Time(s)			
	3 Sample	5 Sample	8 Sample	10 Sample
1	2,81 s	2,55 s	2,56 s	2,81 s
2	3,00 s	2,65 s	2,62 s	2,76 s
3	2,34 s	2,96 s	2,78 s	2,68 s
4	2,92 s	2,83 s	2,23 s	2,23 s
5	2,32 s	2,18 s	2,92 s	3,33 s
6	2,77 s	2,03 s	2,18 s	2,90 s
7	2,27 s	2,75 s	3,23 s	2,74 s
8	2,65 s	2,69 s	2,69 s	2,42 s
9	2,38 s	2,43 s	2,33 s	2,88 s
10	2,51 s	2,86 s	2,91 s	3,85 s
<b>Rate-Rata</b>	2,59 s	2,63 s	2,63s	2,86 s

From the test results in table 2 above, we can see that the response time based on the above test is not much different between 1 *sample* E-KTP cards up to 10 E-KTP cards.

3. Response Time Testing *Touch* Sensor

Response time testing *touch* the sensor is carried out to see the response time of opening the door when the sensor is brought closer to the hand. The purpose of the test is to find out how fast the system can open the door from the inside.

**TABLE 3. RESPONSE TIME TESTING TOUCH SENSOR**

Testing the	Response Time Touch Sensor	Door condition
1	1.52 Seconds	Open
2	2.18 Seconds	Open
3	2.09 Seconds	Open
4	1.89 Seconds	Open
5	2.28 Seconds	Open
6	1.93 Seconds	Open
7	2.12 Seconds	Open
8	2.03 Seconds	Open
9	1.88 Seconds	Open
10	2.01 Seconds	Open
Rate-Rata	1.99 Seconds	Open

From the test results in table 3, it can be seen that the average time needed by *touch* sensor to open the door from the inside is 1.99 seconds.

## B. Discussion

Research with the title Design of an Automatic Unlocking System with Based Notifications *Radio Frequency Identification (RFID)* aims to design a *prototype* RFID based automatic unlocking system. To achieve these objectives, the researchers used the method *Research and Development (R&D)* with research steps which broadly cover potentials and problems, data or information collection, product design/planning stage, design stage, usage trials.

The planning stage is the first step taken to build an automatic door opener system in the form *prototype*, which includes the preparation of tools and materials to be used. The next stage is design *prototype* where after all the equipment has been adequate, then a series is made *software* arduino IDE in the form of a physical circuit to be programmed into a computer. Furthermore, product testing is carried out which is the last step taken to build a system where *prototype* that have been built will be tested starting from E-KTP, RFID sensors, NodeMCU ESP8266, Telegram Bot, servo motors, *Touch* Sensors, Doors, then the results will be seen *prototype* that has been tested whether it is running as expected.

The test is carried out in three stages, consisting of RFID testing which is carried out by bringing the E-KTP card closer to the sensor at a certain distance, if the RFID sensor reads or identifies the ID number on the E-KTP card according to the program, NodeMCU ESP8266 will give an order to open the door and send notifications to the telegram application when someone accesses it. The tool built is said to be successful, from the test results it is known that the sensor can read cards from a distance of 0.0 cm to 1.8 cm.

The second stage is to test the RFID response time, namely to find out how long the RFID response time is after the card is attached until the door is opened, from the test results it is known that the response time needed by RFID to be able to open the door on average ranges from 2.59 to 2.86*second*. Next test the response time *touch* the sensor is done to see the response time of opening the door from inside the room when the sensor is brought close to the hand, from the test results it is known that the response time required until the door is opened is an average of 1.99*second*.

#### 4. Conclusion

Based on the results of research that has been done regarding the design of an automatic unlocking system with RFID-based notifications (*Radio Frequency Identification*) Successful design *prototype* automatic unlock system with RFID based notification (*Radio Frequency Identification*). Work system from *prototype* it is controlled using the NodeMCU ESP8266 as the brain of *prototype* which is equipped with RC522 RFID sensor, servo motor, and *Touch* The sensor for opening the door from within this system can read the E-KTP card to open the door and the system can also send notifications to the telegram application.

#### REFERENCE

- [1] Afrizal Dwi Kusuma. *The Use of Telegram Bot on Telegram Messenger Using the Webhook Method for the Infrastructure Loan System at UIN Maulana Malik Ibrahim Malang*. Malang: UIN Maulana Malik Ibrahim. 2018.
- [2] Ahmad Fahmi. *Design and Build a Cargo Ship Security System to Detect Suspicious Movements Based on the Internet of Thing*. Riau: UIN SUSKA. 2021.
- [3] Ahmad Fahmi. *Design and Build a Cargo Ship Security System to Detect Suspicious Movements Based on the Internet of Thing*. Riau: UIN SUSKA. 2021.
- [4] Akhmad Agil Mubarak. *Design a Prototye Smart Key House with Web-Based RFID E-KTP*. Tegal : Harapan Bersama Polytechnic. 2021.
- [5] Amirullah et al. *Identification and Authentication of Laboratory Room Access Using E-KTP*. Seminar Proceedings. No. 1. Lhokseumawe. 2019.
- [6] Arief Fahmy. Ubaidillah. *Design of a Motor Speed Control System for a Hovercrat Robot Drive with Arduino-Based Automatic Steering*. Jember : University of Jember. 2018.
- [7] Well done Setiaji. Modiyono. *Warning System Using Touch Sensors on the AT 89S51 Microcontroller-Based Automatic LCD Projector Bracket*. Semarang : Diponegoro University. 2018.
- [8] Bayu Aji Prasetya. *Design of RFID and IOT Based Office Door Control Prototype*. Yogyakarta : Yogyakarta Technology University. 2019.
- [9] Benny Naibaho. *Design and Build a Locker Security Tool Using Arduino Pro Mini-Based E KTP*. Medan: Panca Budi Development University. 2021.
- [10] Boss Pandjaitan. *Design and Build a Fire Detection System at Home Based on IoT*. Scientific journals. Bogor. 2021.
- [11] Eko Saputro and Hari Wibawanto. *Design and Build of Automatic Door Security Using Atmega328 Microcontroller-Based E-KTP*. Engineering Journal Electro. Semarang. 2016.
- [12] Ernita Dewi Meutia. *Internet Of Thing- Security and Privacy*. National Seminar and Expo. Banda Aceh. 2015.
- [13] Ernita Dewi Meutia. *Internet of Thing-Security and Privacy*. National Seminar and

- Expo. Banda Aceh. 2015.
- [14] Fear N Simanihuruk. *Design and Build Automatic Door Security Using E-KTP and SMS Gateway-Based Fingerprints*. Medan : University of North Sumatra. 2020.
- [15] Hanafi. *The Concept of R&D Research in the Field of Education*. Journal of Islamic Studies. Banten. 2017.
- [16] I Love Made Caravan. *RFID Implementation in Car Rental Companies*. West Jakarta : Binus University. 2013.
- [17] Lutfhia Indarani Safitri. *Implementation of the RFID Frequency Identification System on Arduino Uno Microcontroller-Based Door Security*. Indralaya: Sriwijaya University. 2018.
- [18] Muhammad Akmal Mulyono. *Simulation of Automatic Fish Netting Tool With Continuous Servo Motor Drive. HC-SR04 Proximity Sensor And Button. Using Arduino Mega*. Scientific Journal of Economics and Business. Semarang. 2019.
- [19] Muhammad Ma'ruf Nur Rifai Risky Via Yuliantari. *Design Analysis of Automatic Door Security Systems Using RFID and Telegram Bots*. National Seminar on Applied Technology Research. Magelang. 2021.
- [20] Rahmat Hidayatullah et al. *Utilizing Telegram Bots as Information Media at Excellent Private School Paiton*. Journal of Excellent Private School Paiton. Probolinggo. 2021.
- [21] Resky Wismsary. Nur Arifah Syah. *Design and build of an Internet of Things IoT-based temperature and humidity monitoring tool at the Jeneponto Health Office Drug Warehouse*. Journal of CIASTECH. Macassar. 2018.
- [22] Ricoh Z. Winerungan dkk.. *Design of Identification Devices at Portal Doors Using the RFID Radio Frequency Identification System*. E-Journal of Electrical and Computer Engineering. Manado. 2014.
- [23] Ryan Laksmana Singgeta et al. "Implementation of RFID Technology in Drinking Water Dispensers". Electrical Journal. Manado. 2019.
- [24] Wahyu Setiawan. *Design of a University Gate Prototype Using RFID with a Microcontroller*. Journal of Bina Darma Conference Engineering Science. Palembang. 2020
- [25] Yoyon Effendi. *Internet Of Things IoT Light Control System Using Mobile-Based Raspberry PI*. Riau: STIMIK Amik. 2018.

# **APPLICATION OF PARTICIPATORY METHODS IN MOTORCYCLE ELECTRICAL MAINTENANCE LEARNING MATERIALS FOR INDUSTRIAL WORK PRACTICES (PRAKERIN) CLASS XI SMK NEGERI 4 BANDA ACEH**

Akmilul Fazlan, Muhammad Rizal Fachri, Husnizar  
Electrical Engineering Education Study Program, Faculty of Tarbiyah &  
Education UIN Ar-Raniry Banda Aceh  
E-mail: [akmilulfazlan19@gmail.com](mailto:akmilulfazlan19@gmail.com)

## **ABSTRACT**

An internship is a specialized activity in which students participate directly in the delivery of training in the working world. Students are actively involved in the learning process when using participatory approaches. According to observations made by researchers at SMK Negeri 4 in Banda Aceh, the majority of students are still limited in their ability to learn due to material issues, especially when it comes to maintenance-related subjects like motorcycle electricity, which benefit from both classroom and real-world practice (DU/DI). The goal of this study is to determine whether it is feasible to use participatory methods to teach students at SMK Negeri 4 Banda Aceh class XI about motorcycle electrical maintenance in stages of planning, implementing, and evaluating learning. The three stages of the participatory method are planning, doing, and assessing learning. According to the study's findings, the participative approach is effective and has an impact on student learning at SMK Negeri 4 Banda Aceh.

**Keywords:** Application of Participatory Methods. Motorcycle Electrical. Industrial Work Practices

## **1. Background**

Education is a program in which interaction between teachers and students serves as the educational process' primary source. In association (education), teaching, training, and guidance, learning activities and educational resources interact. This Industrial Work Practice (PRAKERIN) implementation program is carried out in the work field for Vocational High Schools, particularly Motorcycle Electrical Maintenance, with the goal that with this Prakerin, students can apply the knowledge gained in the classroom to be applied in the field in accordance with their field. In general, vocational high schools (SMK) want to produce graduates that fit their students' knowledge and talents, especially when it comes to their ability to learn co-skills that fit the current market demand. The ability to think critically, creatively, and be able to tackle any problem that arises are all expected outcomes of this exercise. In particular, SMK places a strong emphasis on preparing students for the workplace and the needs of the business and industrial worlds (DU/ DI). In the school learning process, theories are first given to the students.

Law No.20 of 2003 explains that SMK is a secondary education that has the following objectives: (1) preparing students to become productive resources, have the ability to work independently, can fill the needs of labor needs that exist in the field of work in order to become workers at the middle level in line with the abilities in the skills



program of interest; (2) preparing students' abilities to choose careers, tenacity, and persistence in competing, adapting to the work field, and increasing professional attitudes in their chosen fields; (3) equipping students with science, technology, and art, to have the ability to develop their potential in the future both individually and with a higher level of education; (4) equipping students with abilities that are in line with the skills program they choose.

Prakerin is a skill activity that involves students directly in conducting training in the world of work. Prakerin has the aim that students can have various skills in accordance with the wishes of the world of work and industry, this activity can add experience for students in the workplace. Prakerin is a compulsory learning activity carried out by students in the workplace, as a tangible manifestation of an education in SMK. The preparation of this Prakerin activity is carried out by the school and the industry so that students can fulfill all their needs, as well as students' contribution to the world of work in developing learning in SMK.

The purpose of this Prakerin activity is to establish a cooperative relationship between the school and the business world. This Prakerin activity's goal is to develop skills in line with the selected area of expertise so that students may comprehend what is required by business. Teachers play a crucial role in ensuring that students thoroughly comprehend the subject they are taught. The material must be modified to the appropriate approach in order to foster effective learning activity and generate five SMK graduates of the highest caliber. Realizing educational objectives in schools in order to provide efficient learning methods and tactics is the aim of educators.

Participatory learning is a learning model that involves active and fully compulsory students through three important stages: planning, implementation, and evaluation. With this learning method, students can carry out learning together to get and build a structured mindset for the formation of the intended learning objectives. Participatory learning is expected to improve students' abilities by involving them mentally in learning activities. In this activity, students are given freedom and flexibility to develop their potential more optimally.

From the observations that researchers have made at SMK Negeri 4 Banda Aceh, it is found that many students are still constrained in the learning material, especially in the subject of motorcycle electrical maintenance, both when practicing in the school workshop and when practicing in the business world / industrial world (DU / DI). Another problem is also seen in the teaching and learning process of teachers who prioritize the use of the same method without varying, this has made students bored, bored, and less interested in receiving material delivery. Furthermore, researchers also found problems at school when learning in the workshop there are still students who do not understand and master the procedures for using motorcycle electrical equipment and maintenance in accordance with the existing SOP (Standard Operating Procedure). Therefore, researchers want to apply participatory methods to learning materials in order to solve the problems that arise so that they are more effective in conducting Prakerin later.

The objectives to be achieved in this study, namely to determine the test results and feasibility of applying participatory methods with stages (planning, implementation, and evaluation of learning) on motorcycle electrical maintenance material at SMK Negeri 4 Banda Aceh class XI.

## 2. Discussion of Research Results

This study was carried out at the formal educational facility SMK Negeri 4 Banda Aceh, which also has vocational characteristics. The education division of Banda Aceh City is responsible for SMK Negeri 4. This institution offers the TKRO (automotive light vehicle engineering), TBSM (motorcycle engineering and business), and NKPI (fishing boat nautics) specialization programs.

Based on the results of research at SMK Negeri 4 Banda Aceh, the results of the average pretest and posttest scores, the results of the acquisition of data seen in tables 1 and 2, to determine the completeness of student scores refer to the KKM (Minimum Completeness Criteria) value of 75. Based on table 1, the lowest value of student learning outcomes for the pretest is 40 and the highest value is 110. The number of students who reached the KKM limit and were declared complete was 13 people. As for the posttest results based on table 2 above that the lowest student score is 90 and the highest is 130.

TABLE 1. FREQUENCY DISTRIBUTION OF *PRETEST* DATA

No	Nilai	Frekuensi	Tb	Tt	Ta	Frekuensi Relatif
1	40 – 44	3	39,5	42	44,5	15 %
2	45 – 49	0	44,5	47	50,5	0 %
3	50 – 54	4	59,5	52	54,5	20 %
4	55 – 59	0	55,5	57	59,5	0 %
5	60 – 64	4	59,5	62	64,5	20 %
6	65 – 69	0	64,5	67	69,5	0 %
7	70 – 74	5	69,5	72	74,5	25 %
8	75 – 79	0	74,5	77	79,5	0 %
9	80 – 84	2	79,5	82	84,5	10 %
10	85 – 89	2	84,5	87	89,5	10 %

TABLE 2. FREQUENCY DISTRIBUTION OF *POSTTEST* DATA

No	Nilai	Frekuensi	Tb	Tt	Ta	Frekuensi Relatif
1	70 – 74	1	69,5	72	74,5	5 %
2	75 – 79	0	74,5	77	79,5	0 %
3	80 – 84	8	79,5	82	84,5	40 %
4	85 – 89	0	84,5	87	89,5	0 %
5	90 – 94	7	89,5	92	95,5	35 %
6	95 – 99	0	94,5	97	99,5	0 %
7	100 – 104	2	99,5	102	104,5	10 %
8	105 – 109	0	104,5	107	109,5	0 %
9	110 – 114	1	109,5	112	114,5	5 %
10	115 – 119	1	114,5	117	119,5	5 %

The normality test is used to determine whether the sample under study is normally distributed or not, by fulfilling the condition that the data is normally distributed if it meets the criteria for a significant value  $(\alpha) > 0.05$ . For the data normality test in this study, see table 3 below.

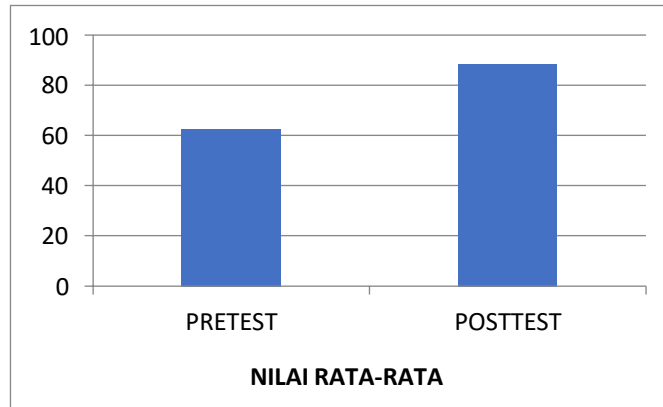

Figure 1 Comparison Chart of *Pretest* and *Posttest*

TABLE 3. NORMALITY TEST RESULTS  
One-Sample Kolmogorov-Smirnov Test

		Unstandardized Residual
N		20
Normal Parameters <sup>a,b</sup>	Mean	.0000000
	Std. Deviation	6.68189231
	Most Extreme Differences	
	Absolute	.088
	Positive	.088
	Negative	-.077
Test Statistic		.088
Asymp. Sig. (2-tailed)		.200 <sup>c,d</sup>

Based on table 3 above shows that the significant value of pretest data is: 0,200. The significant data in this pretest data shows greater than 0.05. So it can be concluded that the data distribution on the pretest is normally distributed. Whereas in the posttest, the significant value is 0.200 and greater than 0.05, so it can be concluded that the distribution of posttest data results is normally distributed. The results of homogeneity testing in this study can be seen below:

TABLE 4. DATA HOMOGENEITY RESULTS  
Test of Homogeneity of Variances

Levene Statistic	df1	df2	Sig.
.299	2	14	.746

Based on the results of the homogeneity test in Table 4, the sig value is  $0.746 > 0.05$ , it can be concluded that the two variants are homogeneous. After carrying out the normality test and homogeneity test, it can be concluded that both samples are normally distributed and homogeneous. Next, the stage to ascertain whether or not there is an effect of the application of learning methods that have been applied, this hypothesis test is to compare the pretest and posttest scores of students. The test in this hypothesis is  $H_a$ : there is an effect of the application of participatory methods on motorcycle electrical material for PRAKERIN. To make a decision whether  $H_a$  is accepted or rejected, it uses a

significant level, namely if significant  $<0.05$  then  $H_a$  is accepted and  $H_o$  is rejected. The results of hypothesis testing in this study can be seen in table 5 below.

TABLE 5. MEAN VALUE  
Paired Samples Statistics

		Mean	N	Std. Deviation	Std. Error Mean
Pair 1	PRETEST	62.50	20	15.517	3.470
	POSTTEST	88.50	20	11.821	2.643

Based on table 5, it can be seen that the average value of the pretest score is 79.5 while the average at the time of the posttest is 102.5. In table 6, it can be seen that the posttest average is greater than the pretest average value.

Table 6 T-Test  
Paired Samples Test

	Paired Differences					T	Df	Sig. (2-tailed)
	Mean	Std. Deviation	Std. Error Mean	95% Confidence Interval of the Difference				
				Lower	Upper			
Pair 1 PRETEST - POSTTEST	-26.000	8.826	1.974	-30.131	-21.869	-13.175	19	.000

Based on table 6 for hypothesis testing with paired sample tests, Sig. (2-tailed) is 0.00. So from the results it can be concluded from the output that  $H_a$  is accepted because  $0.00 < 0.05$ , meaning that the results of the pretest value are different from the posttest, thus it can be concluded that the participatory method has an influence in learning activities.

### 3. Conclusion

Based on the research that has been done. The application of participatory methods is generally classified as good, because it has a positive influence on learning at SMK Negeri 4 Banda Aceh class XI. The implementation is in accordance with the steps, namely: planning, implementation, and assessment. In planning, it is more precise to compile and prepare all the needs at the beginning of learning, in the implementation of all the needs from planning are applied correctly, and in the assessment of the results are in accordance with planning and implementation. This evidence is also seen in the results of the pretest score of 62.5, the results of the posttest score of 88.5, the teacher questionnaire score of 83.62, and the observer questionnaire of 86.18. The assessment of the test results that have been carried out well is evidenced by the results of the normality test showing normal distribution with a value of  $0.200 > 0.05$  on the pretest and posttest, 86.87 while the results of the homogeneity test show a significant value of  $0.0382 > 0.05$ , so the value is homogeneous and the results of the hypothesis test show a significant value of  $0.00 < 0.05$ , meaning that there is an effect of the treatment given between the pretest and posttest.

## REFERENCES

- [1] Arikunto Suharismi. *Research Procedure: A Practice Approach*, Jakarta: Rineka Cipta, 2002.
- [2] Duli Nikolaus. *Quantitative Research Methodology Some Basic Concepts for Thesis Writing and Data Analysis with SPSS*, Yogyakarta: CV Budi Utama, 2019.
- [3] Edi Sarwo, et al. *Development of Standards for the Implementation of Industrial Work Practices PRAKERIN for Vocational Students in the Mechanical Engineering Expertise Program in the Surakarta Region*, Surakarta: Sebelas Maret University 2004.
- [4] Hadi Sutrisno. *Research Methodology*, volume 1: Andi, 2002.
- [5] Syamsunie Carsel HR. *Health and Education Research Methodology*. Yogyakarta: Penebar Media Pustaka, 2018.
- [6] Hadeli. *Education Research Methods*. Ciputat: Ciputat Press, 2006.
- [7] Indahwati Iin. "The Effect of Participatory Learning on Student Learning Outcomes in Islamic Religion Subjects at SMP Negeri 135 Jakarta", UIN Syarif Hidayatullah, 2010.
- [8] Jukianto. *The Effect of Prakerin and the Role of Supervising Teachers on Job Readiness of Marketing Class IX Students at SMK Negeri 1 Jambi City*: Jambi University, 2017.
- [9] Juianto. *The Effect of Prakerin and the Role of the Supervising Teacher on Job Readiness of XI Marketing Class Students of SMK Negeri 1 Jambi*: Jambi University, 2017.
- [10] Kadri Trihono. *Research Design*. Yogyakarta: CV Budi Utama, 2001.
- [11] Notodmojo. *Health Research Methodology*. Jakarta: Rineka Cipta, 2012.
- [12] Nipah Aisatun. *The Influence of Industrial Work Experience (Prakerin), Self-Efficacy, and Accounting Competencies on the Work of Class XII Students in the Accounting Expertise Program at SMK PGRI Salatiga in the 2014/2015 Academic Year*. Semarang: State University of Semarang, 2015.
- [13] Putra Ricardo Leo. *Development of Jobsheet on Motorcycle Electrical Maintenance Subject at SMK PGRI Tanjung Raja*. Tanjung Raya: Sriwijaya University, 2018.
- [14] Sembiring Handanyani Ira Sri. "Application of Participatory Method and Student Learning Motivation in Class IX Qur'an Hadith Subjects at MTs Muhammadiyah 15 Medan", Medan: Muhammadiyah University of North Sumatra, 2020.
- [15] Supardi. *Application of Statistics in Research*. Jakarta: Change Publication, 2013.
- [16] Supardi. *Application of Statistics in Research*. Jakarta: Change Public, 2014.
- [17] Sudaryono. *Education Research Methods*. Jakarta: Prenada Media Group, 2016.
- [18] Sappaile Intang Baso. *The Concept of Educational Research Instruments*. *Journal of Education and Culture*. No.066, May, 2007.
- [19] Sugiyono. *Statistics for Research*. Bandung: Alfabeta, 2013. Uyanto Stanislaus S. *Guidelines for data analysis with SPSS*. Yogyakarta: Graha Ilmu, 2009.
- [20] Turrohah Afifa. *Implementation of Participatory Learning in Qaryah Thayyibah Learning Community in Salatiga*. Semarang: State University of Semarang, 2016.

# DEVELOPMENT OF SENSOR-BASED PROTOTYPE ROBOT FOR AUTOMATED FOOD DELIVERY

Ridwan<sup>1</sup>, Muhammad Fauzan<sup>2</sup>, Hadi Kurniawan<sup>3</sup>

<sup>1</sup>Program Studi Pendidikan Teknologi Informasi, UIN Ar-Raniry

<sup>2</sup>Program Studi Pendidikan Teknik Elektro, UIN Ar-Raniry

<sup>3</sup>Program Studi Teknik Fisika, UIN Ar-Raniry

E-mail: ridwanmt@ar-raniry.ac.id

## Abstract

The food delivery process in Indonesia generally still uses a manual system and queues often occur in stalls at lunch time, especially when an employee is absent or sick. This makes customers have to wait a long time to be able to get food. From the problems above, the researchers took the initiative to create a prototype robot that can deliver food automatically, thereby easing the work of waiters in delivering food. The type of research used is qualitative research using the prototype method. The results show that the robot will move to the destination table by selecting the available menu on the Keypad Shield LCD display. After one of the menus is selected then press the right button on the LCD menu until the Red Table On display appears if red is selected. Then the robot will move towards the destination table according to the input given. If the order is ready to be delivered, the robot will automatically return to its original place. Based on the results of the research above, it was concluded that the prototype could run well and make it easier for business people or restaurants to deliver orders to the consumer's table.

**Keywords:** *LCD Keypad Shield, Prototype, Restaurant, food delivery, Robot..*

## 1. Introduction

The development of technology in the present era has been rapidly advancing, making all lines of human work easier, thus transitioning human life from manual systems to automated systems. The implementation of the 5.0 industrial revolution within the country is still uneven across all regions. Some companies have already implemented robotics technology, but it is still minimal in the culinary industry. The role of a waiter/waitress in a cafe or restaurant is crucial because they directly interact with customers, making it a primary function in advancing a business establishment [1], [2].

Robotics is one of the rapidly developing branches of technology. This development encompasses the fields of mechanics, electronics, and computer science, often referred to as mechatronics. Robotics technology has been widely applied in factory machines, which are useful for producing products in large quantities. Robots have many advantages, including being practical, fast, precise, and capable of working full-time. One commonly used robot is the avoider robot. The avoider robot is a wheeled robot that functions to detect obstacles or barriers in front of it and tries to avoid them [3], [4]. This robot is also equipped with a TCS230 color sensor, which is used to detect colors on each dining table.

In Indonesia, the common practice for delivering food to customers is through waiters/waitresses. Waiters play an important role in establishments such as restaurants, cafes, and others. If a waiter is absent or sick, the company will experience a shortage of staff, which can lead to customer discomfort due to longer waiting times for their orders. To anticipate such situations, the author intends to create a robot that can work in delivering food to customers, making the process more convenient and faster. The use of robots as waiters can also help businesses save expenses since robots do not require food, drinks, and other necessities. A robot only needs sufficient current and voltage to function normally.

This sensor-based food delivery robot operates by pressing the right button on the LCD Keypad Shield display, which will show the "Red Table On" message if the red color is selected. Then, the robot will move towards the designated table. Once the robot reaches the intended table, it will pause briefly to process the order. After a few seconds of delay, the robot will move back to its original position. The LCD display has several menu items that can be selected based on the desired table direction. There are four menu items: Red, Green, Blue, and Clear.

This robot utilizes three ultrasonic sensors positioned in the middle, right side, and left side of the robot. These sensors function to detect obstacles or barriers in front of it. Additionally, the robot is equipped with one TCS230 color sensor, which is used to detect the color beneath the dining table. This sensor is employed as a table identifier. Once the sensor detects the color on the table, the robot will stop and move according to the predetermined instructions. The TCS230 sensor can detect the primary colors of Red, Green, and Blue (RGB).

## 2. Method

The research employed a qualitative approach using the prototype method. The prototype method is an interactive system process where requirements are continuously modified in a working system and improved through user collaboration and analysis.

Based on the above excerpt, users will provide feedback to the researcher regarding the shortcomings and errors of the developed device, allowing the researcher to reanalyze and rectify the mistakes. The nature of the prototype method itself is characterized by constant changes to the device.

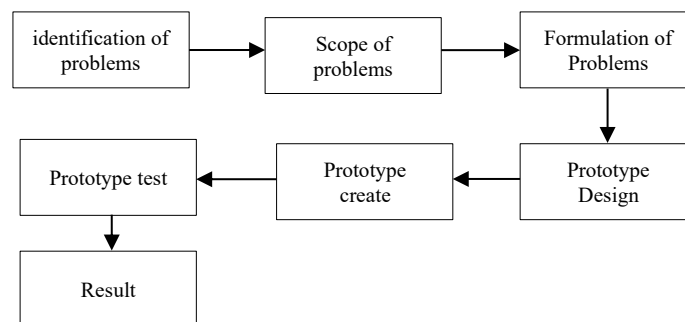

Figure 1. Research Framework

## 3. Flowchart and Design

A flowchart is a graphical representation of the steps and sequence of procedures in a program. The design of a robot should have a clear workflow, ensuring that it is well-

organized and easily understandable for readers [7]. For a clearer understanding, please refer to Figure 2.

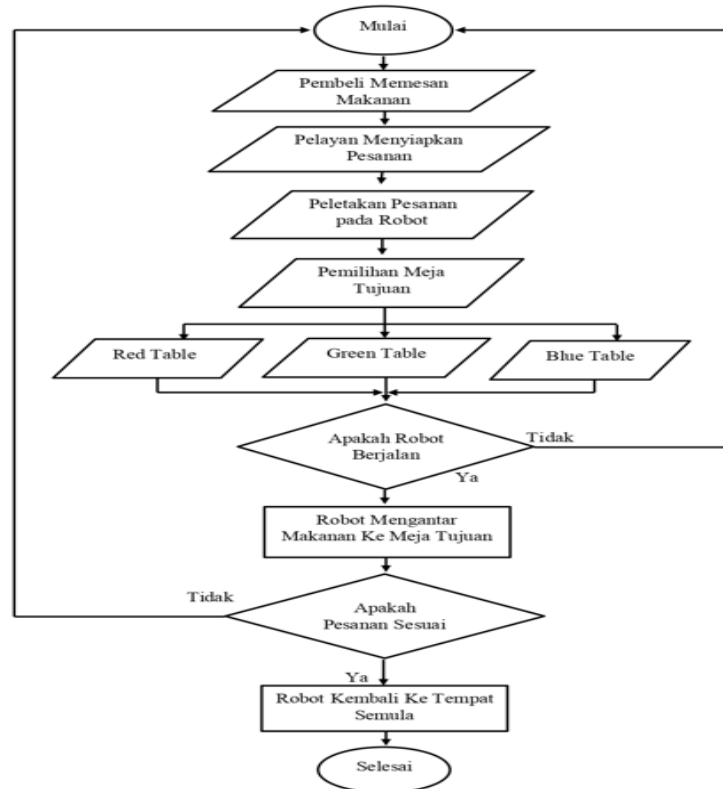

Figure 2. Flowchart

The explanation of each component in the flowchart in Figure 3.3 is as follows:

1. Two terminal symbols, representing the "Start" and "End" points of the information delivery system flowchart.
2. Seven input/output symbols, indicating the input/output processes: orders placed on the robot and commands given for it to move towards a table.
3. Two process symbols, representing the robot starting to move for order delivery and returning to its original position.
4. Two decision symbols, indicating a step for making a decision between "yes" or "no," such as whether the order is correct. If it is correct, the robot will stop, and if it is not, the robot will continue moving.

Robot design is a stage where all the necessary tools and materials are ready for use, followed by the creation of circuit design and the actual construction of the robot. The workflow of this food delivery robot system is crucial as it provides a clear understanding of how the robot should operate, serving as a reference for building the robot. The block diagram of this food delivery robot can be seen in Figure 3.a.



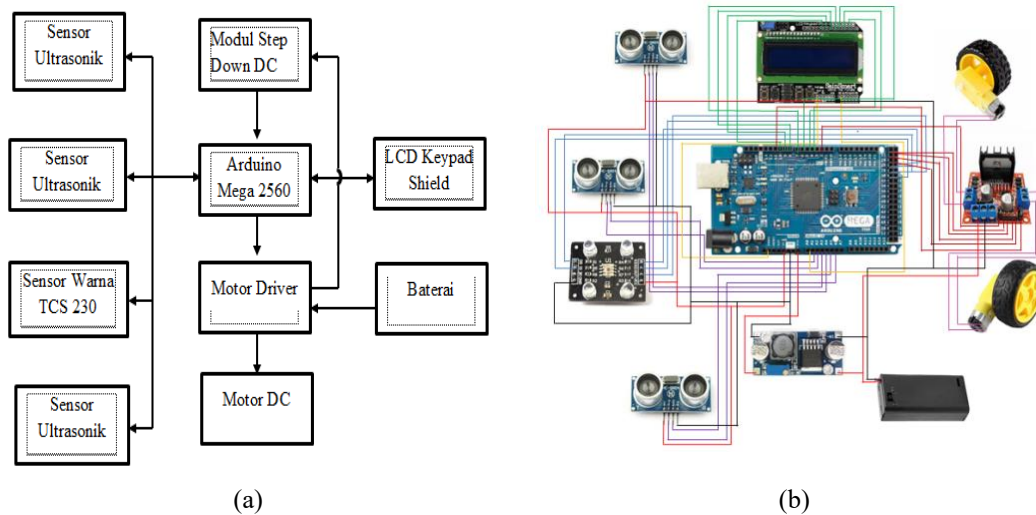

Figure 3. a) Robot Block Diagram, b) Overall Robot Design Concept

The creation of this food delivery robot requires an initial design of the product to ensure a smooth construction process. The circuit design is particularly crucial when developing a complex device because it allows us to troubleshoot errors effectively. It is essential to have a concrete robot circuit design that facilitates our understanding of the necessary components for the project. The robot design concept can be seen in Figure 3.b.

#### 4. Results and Discussions

The testing of the TCS 230 color sensor yielded several results, including the following:

##### a. Testing Different Colors

In this testing, the researcher aimed to determine whether the color sensor could detect colors other than Red, Green, and Blue (RGB) and observe the robot's condition. The results can be seen in Table 1 below.

Table 1. TCS 230 Color Sensor Testing Results Based on Different Colors

	Warna	Keadaan Robot
Sensor Warna TCS 230	Red	Stop
	Yellow	Move
	Green	Stop
	Orange	Move
	Blue	Stop
	White	Move
	Black	Move

##### b. Test at Ultrasonic Sensor

The testing process for the ultrasonic sensor differs from the color sensor testing because the ultrasonic sensor is used to measure distance, while the color sensor is focused on color recognition. The testing process involves several stages, as follows. The ultrasonic sensor can detect objects up to a maximum distance of 4 meters and the closest distance it can detect is 2 cm. The results of the ultrasonic sensor distance testing can be seen in Table 2.

Table 2. Ultrasonic Sensor Testing Results Based on Object Distance

Sensor Ultrasonik	Distance (cm)	Robot Condition
	5	Stop
	10	Stop
	15	Move
	20	Move
	25	Move
	30	Move
	35	Move
	40	Move

## 5. Results and Discussions

The conclusion of the design and development of a sensor-based robot for automated food delivery is as follows:

1. A prototype of a sensor-based robot for automatic food delivery has been successfully designed. In the design of this robot, the Arduino Mega 2560 is used as its microcontroller to control the sensors, which serve as the robot's sensory/detection devices. The working system of this robot is as follows: To start the robot, the power button located on the right side of the robot needs to be activated. Once activated, all the robot's circuits will power on, and the table menu will be displayed on the LCD Keypad Shield. The user can then select the desired table from the menu for food delivery and press the right button until the display shows "Red Table On" if a red table is chosen. The robot will move towards the designated table and will return automatically once the food has been taken.
2. The development of a sensor-based prototype robot for automatic food delivery has been realized because the researcher observed that in Indonesia, the process of food delivery in restaurants is generally still done manually. This situation often leads to long queues at eateries during lunchtime, especially when there are absent or sick employees. As a result, customers have to wait for a considerable amount of time to receive their food. In response to these issues, the researcher took the initiative to create a robot that can autonomously deliver food, thus alleviating the workload of the servers in serving customers.
3. The use of robots as servers is also more cost-effective compared to hiring additional employees, as it helps minimize expenses. Robots do not require wages, so the company only needs to provide regular maintenance to prevent them from getting damaged quickly. With the presence of this food delivery robot, it is expected to assist and facilitate business owners in the food delivery process, while also being beneficial for the community in their day-to-day tasks.

## References

- [1] Diah Aryani, Dkk., Prototype Alat Pengantar Makanan Berbasis Arduino Mega, Jurnal pengkajian dan penerapan teknik, Vol. 12, No. 2, (2019).
- [2] Bagus Widyantoro, Konsumerisme Berlabel Agama Pada Era Revolusi Industri 4.0 Di Indonesia Perspektif Teori Simulacra Dan Hyperreality Jean Baudrillard, Skripsi. Surabaya : Universitas Islam Negeri Sunan Ampel, (2022).
- [3] Bayu Fandidarma, Dkk., Prototipe Robot Avoider sebagai Mesin Penggerak Robot Medical Assistant, Jurnal ELECTRA : Electrical Engineering Articles, Vol.1, No.1, (2020).

- [4] Maysheila Priscilya Sembung, Serwin R.U.A Sompie dan Arie S.M Lumenta. “Rancang Bangun Robot Cerdas Pelayan Restoran”. E-Journal Teknik Elektro dan Komputer vol. 4 no. 6 (2015).
- [5] Kurniawa.A Ramadhan, Dkk, “Perancangan Robot Pengantar Makanan Siap Saji”, Jurnal Elkolind, Vol 8, No 2, (2021).
- [6] Muharto, dan Arisandy Ambarita, Metode Penelitian Sistem Informasi, (Yogyakarta: Deep Perancangan Prototipe Perancangan Prototipe ublish, 2016).
- [7] Ilham Akhsanu Ridlo, Panduan Pembuatan Flowchart, Fakultas Kesehatan Masyarakat Departemen Administrasi Dan Kebijakan Kesehatan, (2017).

**ANALYSIS OF NETWORK PERFORMANCE  
AT SMKN 1 TAKENGON**

Firmansyah<sup>1</sup>, Nikma Marwah Mah Bengi<sup>2</sup>, Hazrullah<sup>3</sup>, Aulia Syarif Aziz<sup>4</sup>  
<sup>1,2,3,4</sup>Prodi Pendidikan Teknologi Informasi, Fakultas Tarbiyah dan Keguruan, UIN Ar-Raniry  
firmansyah.syah@ar-raniry.ac.id

**Abstract**

The Internet Service Provider has the duty as an internet service provider to make comfort and satisfaction of its customers by providing fast and reliable internet access services. There are two important factors in internet speed, namely upload speed and download speed. Bandwidth capacity is the most influential thing to increase the effectiveness of internet speed. This research aims to analyze throughput and delay of internet network using QoS (Quality of Service) parameters. Wireshark is used in measuring the performance of this network. The research was conducted at the computer laboratory of SMKN 1 Takengon. The results of data analysis suggested that the network performance at SMKN 1 Takengon using throughput and delay parameters is in the feasible and very good category where throughput has the average index is 3.8 in the good category. While for delay, it is getting an average index of 4 which is in the very good category.

**Keywords:** quality of service, delay, throughput

**1. Introduction**

The development of computer network technology is currently needed to meet the quality and quantity of fast and reliable internet access [1]. There are many requests for internet access for universities, office areas, schools and for various activities that require very fast quality internet access to support their work.

In the process of communicating to be able to send or receive information, good service performance is needed to support a communication process so that the information to be conveyed can be received properly [2]. ISPs or Internet Service Providers who serve as information service providers are trying every way to fulfill the comfort and satisfaction of their customers so that they can always access the internet. The Internet or Interconnection networking is a whole unit of computers that can be connected to communicate based on the global standardization of TCP/IP (Transmission Control Protocol/Internet Protocol Suite) functions in terms of serving billions of users around the world for packet switching (packet switching communication protocol) [3]. There are two most important factors for internet speed, namely upload speed and download speed. Bandwidth capacity is something that is most influential in increasing the effectiveness of an internet speed. The term used to describe the amount of data or information sent in a unit of time symbolized by bits per second (bps), Kilobits per second (Kbps) and Megabytes per second (Mbps) through an internet connection is called bandwidth [4].

The method used to measure network quality and also one of the attempts to explain the criteria and characteristics of a service is called Quality of Service (QoS). This method is used to test or measure a group of work attributes that have previously been detailed and collected by a service. QoS refers to the ability of a network to provide better service to certain network traffic through different technologies, besides that the Quality of Service method also has the ability to describe the attributes that have been provided for network services quantitatively and qualitatively [3].

In this study, to determine the quality of internet network services, there are two parameters that will be used, namely throughput and delay according to Telecommunications and Internet Protocol Harmonization Over Network (TIPHON) standards. Quality of Service (QoS) is

## ANALYSIS OF NETWORK PERFORMANCE AT SMKN 1 TAKENGON

designed to make it easier for clients (end users) to be more useful by ensuring that users (users) get reliable performance through network-based applications. The purpose of QoS analysis is to be able to monitor the quality of services provided by ISPs (Internet Service Providers) and network operators. The tool used by administrators to monitor the network is Wireshark.

Wireshark is software that analyzes free and open source packages. This application is very useful for administrators because it is used in solving problems that exist in the network, monitoring the network, analyzing network performance and monitoring data travel in the network that is set by wireshark [5]. The Wireshark tool can also capture data and information packets that are currently running in a wireless local area network (WLAN) network.

SMK Negeri 1 Takengon has 4 buildings, 3 floors and 2 computer labs, each consisting of 30 computers with a total number of students of 1,232. To fulfill every learning activity that takes place, this school has built a network service. Of the 33 study groups at the school, there are several departments that use the lab regularly for practicums including multimedia and computer network engineering. Then the accounting, banking and office administration departments also alternately use the computer lab for data processing and searching for information obtained via the internet.

Slow internet network access makes students feel dissatisfied, apart from that there are also several problems and disturbances that occur on wire and wireless networks and these are difficult to avoid, as a result of these disturbances the performance of a network decreases. To determine the effectiveness of a network can be measured through parameters based on the performance of the network. In order to maintain network access so that it remains stable in using the internet network, it is necessary to analyze and test network performance or Quality of Service at SMK N 1 Takengon so that problems that often occur such as delays in data transmission can be minimized so that the management of internet service quality can function properly.

From these problems, the researcher is interested in analyzing and measuring performance on internet network services at SMK N 1 Takengon to see the smooth use of the internet network. The performance measurement in question is Quality of Service (QoS) which consists of Throughput and delay in the SMK N 1 Takengon environment so that the quality of internet network service can be known according to the percentage of the Quality of Service standardization.

## 2. Method

In order to get maximum results, it is necessary to carry out the steps of activities in carrying out this final project. The steps consist of:

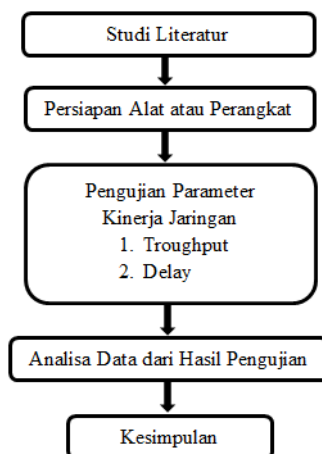

Figure 1. Research Method

## ANALYSIS OF NETWORK PERFORMANCE AT SMKN 1 TAKENGON

### 2.1. Literature Review

Literature review is looking for theoretical references related to the cases or problems found. The reference contains about:

1. Computer networks
2. Quality of Service (QoS) parameter
3. Wireshark

In looking for these references, we go through books, journals, research report articles, sites and tutorials on the internet. The output of the literature study discussed in this study is to collect references that are relevant to the formulation of the problems discussed.

### 2.2. Devices Preparation

The following hardware and software are used to measure and analyze internet network services. The devices used are as follows. Laptop HP 64-bit operating system, x64-based processor Intel® Core™ i5-8250U CPU @ 1.60GHz 1.80, 4.00 GB RAM and 1 TB hard drive. Windows 10 Operating System and Wireshark 3.6.5

### 2.3. Network Parameter Testing

Quality of Service (QoS) is a technique for measuring how good a network is and attempts to define a characteristic and device of a service. QoS is used to measure a certain set of performance attributes associated with a service [6]. The QoS parameters that will be measured include:

#### a. Throughput

Throughput is the effective data transfer rate in bits per second. Throughput is the total number of packets that are observed to successfully reach their destination in a certain interval divided by the duration of that interval [7].

Table 1. Throughput standard

Category	Troughput	Index
Very good	100 %	4
Good	75 %	3
Average	50%	2
Bad	<25%	1

#### b. Delay

Delay is the time it takes data in the range from the starting point to the center point. The factors that affect delay include: distance, physical media and also quite a long processing time [8].

Table 2. Delay standard

Category	Delay	Index
Very good	<150 ms	4
Good	150 s/d 300 ms	3
Average	300 s/d 400 ms	2
Bad	>450 ms	1

The application used in testing internet network analysis using QoS parameters which include Throughput, Packet Loss and Delay is Wireshark [2].

## 3. Results and Discussions

Based on the results of data collection that was carried out during the research, the parameter measurements based on Quality of Service were obtained as follows:

**ANALYSIS OF NETWORK PERFORMANCE  
AT SMKN 1 TAKENONG**

a. Throughput

From the results of data retrieval throughput based on the large number of packets or data that reaches the recipient within a predetermined period of time. The measurement results are presented in Table 3 below.

Table 3. Troughput Measurement Results

Day	Application	Throughput		
		Value	Index	Category
Monday (1)	Zoom	1,155 Mbps	3	Good
	Google Meet	2,125 Mbps	4	Very Good
	Youtube	3,08 Mbps	4	Very Good
Tuesday (2)	Zoom	8,42 Mbps	4	Very Good
	Google Meet	3,488 Mbps	4	Very Good
	Youtube	5,32 Mbps	4	Very Good
Wednesday (3)	Zoom	6,85 Mbps	4	Very Good
	Google Meet	2,071 Mbps	4	Very Good
	Youtube	1,450 Mbps	3	Good
Thursday (4)	Zoom	7,36 Mbps	4	Very Good
	Google Meet	3,599 Mbps	4	Very Good
	Youtube	3,81 Mbps	4	Very Good
Friday (5)	Zoom	1,328 Mbps	3	Good
	Google Meet	2,125 Mbps	4	Very Good
	Youtube	6,15 Mbps	4	Very Good

From Table 3 the results of the throughput test at the Computer Lab SMKN 1 Takengon which has been researched for 5 days shows that the resulting throughput value with index 4 is a very good category and index 3 is a good category, this shows that the performance or quality of the network in the laboratory belong to the very good category.

For testing on Zoom and Youtube on Mondays, Wednesdays and Fridays who get good categories with index 3, get these results because fair queues are not given, users who send large packets will get higher bandwidth. Apart from this, other factors can also be caused by network quality and during peak hours, the internet will be slow, possibly because the ISP's bandwidth allocation is congested. So that data packets sent or received experience pending [14].

b. Delay

The following delay measurement results are presented in Table 4 below:

Table 4. Delay Measurement Results

Day	Application	Delay		
		Value	Index	Category
Monday (1)	Zoom	7 ms	4	Very Good
	Google Meet	2 ms	4	Very Good
	Youtube	23 ms	4	Very Good
Tuesday (2)	Zoom	33 ms	4	Very Good
	Google Meet	2 ms	4	Very Good
	Youtube	14 ms	4	Very Good
Wednesday (3)	Zoom	8 ms	4	Very Good
	Google Meet	2 ms	4	Very Good
	Youtube	887 ms	1	Bad

**ANALYSIS OF NETWORK PERFORMANCE  
AT SMKN 1 TAKENONG**

Thursday (4)	Zoom	8 ms	4	Very Good
	Google Meet	2 ms	4	Very Good
	Youtube	19 ms	4	Very Good
Friday (5)	Zoom	4 ms	4	Very Good
	Google Meet	2 ms	4	Very Good
	Youtube	9 ms	4	Very Good

The average value of the delay index obtained based on the test results during the study was 4 with a very good category. The average delay value generated from Monday to Thursday is to produce a satisfactory value with a very good index of 4 categories.

Based on network performance test data that has been carried out using the QoS method with throughput and delay parameters that have been tested in the internet network in the SMKN 1 Takengon computer laboratory using the wireshark application, the results showed that it is in accordance with the percentage of Quality of service (QoS) according to standardization TIPHON (Telecommunications and Internet Protocol Harmonization Over Network) and belongs to the category of decent and very good network performance.

#### **4. Summary**

Based on the results of network performance testing using the QoS method with throughput and delay parameters at SMKN 1 Takengon, it can be concluded that the parameters used in this test consist of throughput and delay. Get the result that, the throughput value gets an average index of 3.8 in the "good" category. And delay gets an average index of 4, entering the "very good" category. Based on research on testing internet network performance in the Computer Laboratory at SMKN 1 Takengon, there is a suggestion that further researchers are expected to be able to add tests on Jitter Parameters and use testing tools or applications other than wireshark.

#### **References**

- [1] C. Wijaya, H. Aspriyono, and A. Al Akbar, "Pengembangan Infrastruktur Jaringan Berbasis Nirkabel Ke Jaringan Berteknologi Gpen (Gigabit Passive Ethernet Network) Di Kampus Iain Bengkulu," *J. Amplif. J. Ilm. Bid. Tek. Elektro Dan Komput.*, vol. 11, no. 1, pp. 14–21, 2021, doi: 10.33369/jamplifier.v11i1.16064.
- [2] A. R. Maulana, H. Walidainy, M. Irhamsyah, F. Fathurrahman, and A. Bintang, "Analisis Quality of Service (Qos) Jaringan Internet Pada Website E-Learning Univiersitas Syiah Kuala Berbasis Wireshark," *J. Komputer, Inf. Teknol. dan Elektro*, vol. 6, no. 2, pp. 27–30, 2021, doi: 10.24815/kitektro.v6i2.22284.
- [3] N. Verona, V. Kamasi, and N. W. Kamasi, "Analisis Quality Of Service pada Jaringan Internet di Universitas Sariputra Indonesia Tomohon," vol. 4, no. November, 2021.
- [4] R. Pratama, J. D. Irawan, M. Orisa, and F. T. Industri, "ANALISIS QUALITY OF SERVICE SISTEM MANAJEMEN BANDWIDTH PADA JARINGAN LABORATORIUM TEKNIK INFORMATIKA ITN MALANG," vol. 6, no. 1, pp. 196–204, 2022.
- [5] R. Tri, I. Gunawan, I. Marleni, O. Gregarius, and M. Nanda, "Analisis Keamanan Wifi Menggunakan Wireshark," *JES ( J. Elektro Smart )*, vol. 1, no. 1, pp. 1–3, 2021.
- [6] T. Informasi and D. A. N. Komunikasi, "No Title," vol. 7, no. 2, pp. 98–105, 2018.
- [7] M. Y. Simargolang and A. Widarma, "Quality Of Service ( QoS ) Untuk Analisis Performance Jaringan Wireless Area Network ( WLAN ) Quality Of Service ( QoS ) For Network Performance Analysis Wireless Area Network ( WLAN )," vol. 7, no. January, pp. 162–171, 2022.
- [8] Aprianto Budiman, M. Ficky Duskarnaen, and Hamidillah Ajie, "Analisis Quality of



**ANALYSIS OF NETWORK PERFORMANCE  
AT SMKN 1 TAKENONG**

- Service (Qos) Pada Jaringan Internet Smk Negeri 7 Jakarta,” *PINTER J. Pendidik. Tek. Inform. dan Komput.*, vol. 4, no. 2, pp. 32–36, 2020, doi: 10.21009/pinter.4.2.6.
- [9] I. P. Sari, “Jurnal Sistim Informasi dan Teknologi Evaluasi Kualitas Jaringan Internet Pemerintah Daerah Kota Padang Panjang Menggunakan Metode Quality of Service,” vol. 4, pp. 1–3, 2022, doi: 10.37034/jsisfotek.v4i1.116.
- [10] V. Wahanggara, “Analisa Quality of Service ( Qos ) Pada Smk Baitul,” *Anal. Qual. Serv. ( Qos ) Pada Smk Baitul*, pp. 1–20, 2016, [Online]. Available: <http://repository.unmuhjember.ac.id/2636/>
- [11] I. P. Agus, E. Pratama, and K. C. Bakkara, “Pengujian QoS Pada Implementasi SDN Berbasis Mininet dan OpenDaylight Menggunakan Topologi Tree,” vol. 10, pp. 170–175, 2021.
- [12] S. Turangga and Y. A. W, “ANALISIS INTERNET MENGGUNAKAN PARAMETER QUALITY OF SERVICE PADA ALFAMART TUPAREV 70,” vol. 6, no. 1, pp. 392–398, 2022.
- [13] T. G. Afrizal Martin, Akni Widiyastuti, “Pengembangan Infrastruktur Jaringan Komputer Untuk Computer Based Test ( Cbt )/ Android Based Test ( Abt ) Pada Smks Budi Utama Pringsewu,” *JISN (Jurnal Inform. Softw. dan Network)*, vol. 02, no. 02, pp. 57–75, 2021, [Online]. Available: <http://jurnal.dccpringsewu.ac.id/index.php/ji/article/view/29/22>
- [14] Aprilyano Ekklesia Tangkowitz, Verry Ronny Palilingan, and Olivia Eunike Selvie Liando, “Analisis dan Perancangan Jaringan Komputer Di Sekolah Menengah Pertama,” *EduTIK*, vol. 1, no. 1, pp. 69–81, 2021
- [15] K. Kurniawan and A. Prihanto, “Analisis Quality Of Service ( QoS ) Pada Routing Protocol OSPF ( Open Short Path First ),” vol. 03, pp. 358–364, 2022.
- [16] T. R. Rachmadi, “Analisis Kinerja Jaringan Wireless LAN Menggunakan Metode QOS (Quality of Service) Di Perpustakaan SMK Negeri 5 Bandar Lampung,” *J. Eng. Comput. Sci. ...*, vol. 1, no. 1, pp. 110–117, 2021.
- [17] A. Salim and C. Mukmin, “Analisis Kinerja Jaringan Internet Pada Smk Muhammadiyah 2 Palembang,” *Bina Darma Conf. ...*, pp. 124–130, 2021, [Online]. Available: <https://conference.binadarma.ac.id/index.php/BDCCS/article/view/2206%0Ahttps://conference.binadarma.ac.id/index.php/BDCCS/article/download/2206/869>
- [18] P. T. Mahmud, “Sniffing Jaringan Menggunakan Wireshark,” *J. Jar. Komput.*, pp. 5–8, 2020.
- [19] P. Pangestu, P. T. Elektro, U. Sultan, and A. Tirtayasa, “PADA LAYANAN INTERNET BERBASIS MIKROTIK,” vol. 8, no. 1, pp. 8–17, 2021.
- [20] T. Octavianto, “Pemanfaatan Hierachical Token Bucket Dalam Konsep Jaringan Untuk Pengoptimalan Bandwidth,” *J. Inf. Technol.*, vol. 1, no. 2, pp. 43–46, 2021, doi: 10.32938/jitu.v1i2.1101.
- [21] D. Apriana and M. H. B. H. Avicena, “Analisa Jaringan Local Area Network Pada Laboratorium Komputer SMK Informatika Kota Serang,” vol. 3, no. 1, pp. 23–31, 2022.
- [22] N. Nurdadyansyah and M. Hasibuan, “Tampilan Perancangan Local Area Network Menggunakan NDLC Untuk Meningkatkan Layanan Sekolah,” *Konf. Nas. Ilmu Komput.*, pp. 342–346, 2021, [Online]. Available: <https://prosiding.konik.id/index.php/konik/article/view/75/68>
- [23] A. Posumah, J. Waworuntu, and T. Komansilan, “EduTIK: Jurnal Pendidikan Teknologi Informasi dan Komunikasi,” *EduTIK J. Pendidik. Teknol. Informasidan Komun.*, vol. 1, no. 6, pp. 675–687, 2021, [Online]. Available: <https://ejurnal.unima.ac.id/index.php/edutik/article/view/3293>
- [24] P. Studi, M. Informatika, A. Manajemen, and K. Serang, “ANALISIS MONITORING SISTEM JARINGAN KOMPUTER MENGGUNAKAN APLIKASI SPICEWORKS,” vol. 9, no. 1, 2022.

**ANALYSIS OF NETWORK PERFORMANCE  
AT SMKN 1 TAKENGON**

- [25] D. Arifianto, A. Sulistiono, and A. Nilogiri, "Jurnal Sistem dan Teknologi Informasi Sistem Monitoring Suhu Dan Kelembaban Ruangan Server Berbasis Arduino Menggunakan Metode Fuzzy Logic Dengan Buzzer Dan Telegram Bot Sebagai Notifikasi," vol. 7, no. 1, pp. 67–75, 2022.
- [26] R. N. Dasmen, K. Pangestu, and K. Saputra, "Aplikasi Mikrotik Dasar Sebagai Pembatasan Bandwidth pada Warung Internet Teranet One di Prabumulih," *J. Komput. dan Inform.*, vol. 10, no. 1, pp. 72–77, 2022, doi: 10.35508/jicon.v10i1.6270.
- [27] S. H. Wicaksana *et al.*, "Perancangan Infrastruktur Teknologi Informasi Adaptif Dengan Metode Ppdioo Untuk Mendukung Implementasi Sistem Informasi Manajemen Puskesmas Studi Kasus : Puskesmas Jatilawang," vol. 9, no. 2, pp. 686–692, 2022.
- [28] U. Atma and J. Yogyakarta, "Perancangan Blueprint dan Pembangunan Jaringan Komputer Gereja Brayat Minulya Yogyakarta," vol. 1, no. 1, pp. 1–11, 2022.
- [29] G. M. Ibrahim *et al.*, "CISCO PACKET TRACER DAN TOPOLOGI LAN DI SMK MADANI DEPOK," vol. 3, pp. 52–56, 2022.
- [30] N. N. Niana, "Analisis Perbandingan Performa Mode Trafik TCP dan UDP Menggunakan Protokol Routing AODV dan DSR pada Jaringan MANET," *J. Teknol. Informasi, Komputer, dan ...*, vol. 4, no. 1, pp. 21–26, 2022, [Online]. Available: <http://jtika.if.unram.ac.id/index.php/JTIKA/article/view/162>
- [31] D. Nataliana, F. Hadiatna, and Y. Maulida, "Sistem Monitoring Infus dengan Human Machine Interface secara Wireless," vol. 10, no. 2, pp. 470–483, 2022, [Online]. Available: <http://dx.doi.org/10.26760/elkomika.v10i2.470>

ISSN 2987-2219



9

772987

221006

